

brother®

TZ
TAPE

P-touch®

1400

USER'S GUIDE
GUÍA DE USUARIO



- Read this User's Guide before you start using your P-touch.
- Keep this User's Guide in a handy place for future reference.
- Antes de usar su equipo por primera vez, lea cuidadosamente esta guía de usuario.
- Guarde esta guía de usuario para futuras referencias.

Introduction

Thank you for purchasing this P-touch!

With your new P-touch, select from a variety of character styles, sizes and frames to design practical custom labels for any need. In addition, the selection of pre-formatted label types allows you to quickly and easily label patch panels, cables, connectors and other components.

With this P-touch, you can print legible, long-lasting labels in no time. The quality and performance of this P-touch make it an extremely practical machine in the plant or in the field.

Although this P-touch is easy to use, we suggest that you read this User's Guide carefully before starting, and then keep this manual nearby for future reference.

Federal Communications Commission (FCC) Declaration of Conformity (For USA Only)

Responsible Party : Brother International Corporation
100 Somerset Corporate Boulevard
Bridgewater, NJ 08807-0911 USA
TEL : (908) 704-1700

declares that the product
Product Name : Brother Label Printer P-touch
Model Number : PT-1400

complies with Part 15 of the FCC Rules. Operation is subject to the following two conditions: (1) this device may not cause harmful interference, and (2) this device must accept any interference received, including interference that may cause undesired operation.

This equipment has been tested and found to comply with the limits for a Class B digital device, pursuant to Part 15 of the FCC Rules. These limits are designed to provide reasonable protection against harmful interference in a residential installation. This equipment generates, uses, and can radiate radio frequency energy and, if not installed and used in accordance with the instructions, may cause harmful interference to radio communications. However, there is no guarantee that interference will not occur in a particular installation. If this equipment does cause harmful interference to radio or television reception, which can be determined by turning the equipment off and on, the user is encouraged to try to correct the interference by one or more of the following measures:

- Reorient or relocate the receiving antenna
- Increase the separation between the equipment and receiver.
- Connect the equipment into an outlet on a circuit different from that to which the receiver is connected.
- Consult the dealer or an experienced radio/TV technician for help.
- The enclosed interface cable should be used in order to ensure compliance with the limits for a Class B digital device.
- Changes or modifications not expressly approved by Brother Industries, Ltd. could void the user's authority to operate the equipment.

CONTENTS

Brother® 90 Days/One Year Limited Warranty and Replacement Service (For USA Only)	iii
Important Information	v

1. Getting Started 1

General Description	1
<i>Top view & bottom view</i>	1
<i>Keyboard & LCD display</i>	2
General Precautions	3
Batteries & Tape Cassettes	4
<i>Installing batteries and a tape cassette</i>	4
Cleaning	7
<i>Cleaning the print head, rollers and tape cutter</i>	7
Optional AC Adapter	8
<i>Connecting the AC adapter</i>	8
Turning the P-touch On/Off	8

2. Label Type Modes 9

Selecting a Label Type Mode	9
Normal and Vertical Modes	9
Rotate Mode and Rotate & Repeat Mode	10
Flag Mode	11
Port & Panel Modes	12

3. Basic Functions 14

Performing Basic Operations	14
<i>Choosing functions, parameters, settings and groups</i>	14
<i>Choosing the default setting</i>	14
<i>Confirming a choice</i>	14
<i>Cancelling a choice</i>	14
Inputting Label Data	15
<i>Entering and editing text</i>	15
<i>Entering an accented character</i>	17
<i>Entering a bar code</i>	18
<i>Entering a symbol</i>	20

Formatting the Label	23
<i>Specifying a label length</i>	23
<i>Specifying a margin size</i>	23
<i>Framing the text</i>	24
<i>Specifying the character size</i>	25
<i>Specifying the character width</i>	26
<i>Specifying the character style</i>	27
<i>Using the pre-formatted Auto Format templates</i>	29
Printing Labels	30
<i>Previewing the label layout</i>	30
<i>Feeding tape</i>	30
<i>Printing a label</i>	30
<i>Using special printing functions</i>	31
Storing and Recalling Files	35
<i>Storing label text</i>	35
<i>Recalling text that has been stored</i>	36
<i>Deleting text that has been stored</i>	36

4. Machine Adjustments37

<i>Selecting how tape is fed and cut</i>	37
<i>Adjusting the display contrast</i>	37
<i>Setting the Auto Reduction function</i>	38
<i>Calibrating the label length</i>	38
<i>Specifying if the PERSONAL symbol category is continually updated</i>	39
<i>Changing the units of measure</i>	39
<i>Changing the language</i>	39
<i>Displaying version information</i>	39

5. Appendix40

Troubleshooting	40
Error Message List	41
Machine Specifications	45
<i>Hardware</i>	45
<i>Software</i>	45
Index	46
Contact Information (For USA Only)	49

Brother® 90 Days/One Year Limited Warranty and Replacement Service (For USA Only)

Who is covered:

- This limited warranty (“warranty”) is given only to the original end-use/retail purchaser (referred to in this warranty as “Original Purchaser”) of the accompanying product, consumables and accessories (collectively referred to in this warranty as “this Product”).
- If you purchased a product from someone other than an authorized Brother reseller in the United States or if the product was used (including but not limited to floor models or refurbished product), prior to your purchase you are not the Original Purchaser and the product that you purchased is not covered by this warranty.

What is covered:

- This Product includes a Machine and Consumable and Accessory Items. Consumable and Accessory Items include but are not limited to label cassettes, cutters, stamps, power adapters, cases and batteries.
- Except as otherwise provided herein, Brother warrants that the Machine and the accompanying Consumable and Accessory Items will be free from defects in materials and workmanship, when used under normal conditions.
- This warranty applies only to products purchased and used in the United States. For products purchased in, but used outside, the United States, this warranty covers only warranty service within the United States (and does not include shipping outside the United States).

What is the length of the Warranty Period(s):

- Machines have a two-stage warranty: 90 days from the original purchase date and an additional warranty up to one year from the original purchase date.
- Consumable and Accessories Items accompanying the Machine have a one-stage warranty: 90 Days from the original purchase date.

What is NOT covered:

This warranty does not cover:

- (1) Physical damage to this Product;
- (2) Damage caused by improper installation, improper or abnormal use, misuse, neglect or accident (including but not limited to transporting this Product without the proper preparation and/or packaging);
- (3) Damage caused by another device or software used with this Product (including but not limited to damage resulting from use of non Brother®-brand parts and Consumable and Accessory Items);
- (4) Consumable and Accessory Items that expired in accordance with a rated life; and,
- (5) Problems arising from other than defects in materials or workmanship.

This limited warranty is VOID if this Product has been altered or modified in any way (including but not limited to attempted warranty repair without authorization from Brother and/or alteration/removal of the serial number).

What to do if you think your Product is eligible for warranty service:

Report your issue to either our Customer Service Hotline at 1-877-478-6824 or a Brother Authorized Service Center within the applicable warranty period. Supply Brother or the Brother Authorized Service Center with a copy of your dated bill of sale showing that this Product was purchased within the U.S. For the name of local Brother Authorized Service Center(s), call 1-800-521-2846.

What Brother will ask you to do:

After contacting Brother or a Brother Authorized Service Center, you may be required to deliver (by hand if you prefer) or send the Product properly packaged, freight prepaid, to the Authorized Service Center together with a photocopy of your bill of sale.

You are responsible for the cost of shipping, packing product, and insurance (if you desire). You are also responsible for loss or damage to this Product in shipping.

What Brother will do:

First 90 Days: If the problem reported concerning your Machine and/or accompanying Consumable and Accessory Item(s) is covered by this warranty and if you first reported the problem to Brother or an Authorized Service Center within 90 days from the date of original purchase, Brother or its Authorized Service Center will repair or replace the Machine and/or accompanying Consumable and Accessory Item(s) at no charge to you for parts or labor. The decision as to whether to repair or replace the Machine and/or accompanying Consumable and Accessory Item(s) is made by Brother in its sole discretion. Brother reserves the right to supply a refurbished or remanufactured replacement Machine and/or accompanying Consumable and Accessory Item(s) and use refurbished parts provided such replacement products conform to the manufacturer's specifications for new product/parts. The repaired or replacement Machine and/or accompanying Consumable and Accessory Item(s) will be returned to you freight prepaid or made available for you to pick up at a conveniently located Authorized Service Center.

Brother® 90 Days/One Year Limited Warranty and Replacement Service (For USA Only)

91st day to 1 year:

If the problem reported concerning your Machine is covered by this warranty and if you first reported the problem after 90 days, but before 1 year from the date of original purchase, Brother will furnish, free of charge (excluding labor charges), replacement part(s) for those part(s) of the Machine determined by Brother or its Authorized Service Center to be defective. **You will be responsible for all labor charges associated with repairs made after the first 90 days from original purchase.** After 90 days from the original purchase date, accompanying Consumable and Accessory Items are no longer covered by this warranty. If the Machine and/or accompanying Consumable and Accessory Item(s) are not covered by this warranty (either stage), you will be charged for shipping the Machine and/or accompanying Consumable and Accessory Item(s) back to you.

The foregoing are your sole (i.e., only) and exclusive remedies under this warranty.

What happens when Brother elects to replace your Machine:

If you have delivered the Machine to an Authorized Service Center, the Authorized Service Center will provide you with a replacement Machine after receiving one from Brother. If you are dealing directly with Brother, Brother will send to you a replacement Machine with the understanding that you will, after receipt of the replacement Machine, supply the required proof of purchase information, together with the Machine that Brother agreed to replace. You are then expected to pack the Machine that Brother agreed to replace in the package from the replacement Machine and return it to Brother using the air bill supplied by Brother in accordance with the instructions provided by Brother. Since you will be in possession of two machines, Brother will require that you provide a valid major credit card number. Brother will issue a hold against the credit card account number that you provide until Brother receives your original Product and determines that your original Product is entitled to warranty coverage. Your credit card will be charged up to the cost of a new Product only if:

(i) you do not return your original Product to Brother within five (5) business days; (ii) the problems of your original Product are not covered by the limited warranty; (iii) the proper packaging instructions are not followed and has caused damage to the product; or (iv) the warranty period on your original Product has expired or has not been sufficiently validated with a copy of the proof of purchase (bill of sale). The replacement Machine you receive (even if refurbished or remanufactured) will be covered by the balance of the limited warranty period remaining on the original Product, plus an additional thirty (30) days. You will keep the replacement Machine that is sent to you and your original Machine shall become the property of Brother. **Retain your original accessory items and a copy of the return air bill, signed by the courier.**

Limitations:

Brother is not responsible for damage to or loss of any equipment, media, programs or data related to the use of this Product. Except for that repair or replacement as described above, Brother shall not be liable for any direct, indirect, incidental or consequential damages or specific relief. Because some states do not allow the exclusion or limitation of consequential or incidental damages, the above limitation may not apply to you.

THIS WARRANTY IS GIVEN IN LIEU OF ALL OTHER WARRANTIES, WRITTEN OR ORAL, WHETHER EXPRESSED BY AFFIRMATION, PROMISE, DESCRIPTION, DRAWING, MODEL OR SAMPLE. ANY AND ALL WARRANTIES OTHER THAN THIS ONE, WHETHER EXPRESS OR IMPLIED, INCLUDING IMPLIED WARRANTIES OF MERCHANTABILITY AND FITNESS FOR A PARTICULAR PURPOSE, ARE HEREBY DISCLAIMED.

- This Limited Warranty is the only warranty that Brother is giving for this Product. It is the *final expression and the exclusive and only statement* of Brother's obligations to you. It replaces all other agreements and understandings that you may have with Brother or its representatives.
- This warranty gives you certain rights and you may also have other rights that may vary from state to state.
- This Limited Warranty (and Brother's obligation to you) may not be changed in any way unless you and Brother sign the same piece of paper in which we (1) refer to this Product and your bill of sale date, (2) describe the change to this warranty and (3) agree to make that change.

Important:

We recommend that you keep all original packing materials, in the event that you ship this product.

Important Information

Should you have questions, or need information about your Brother Product, we have a variety of support options for you to choose from:

USA-Customer Service:
Customer Service
877-478-6824 (voice)

Customer Service
901-379-1210 (fax)

Automated Faxback
800-521-2846

World Wide Web
www.brother.com

Supplies / Accessories
www.brothermall.com
or 888-879-3232

**BROTHER INTERNATIONAL CORPORATION
100 SOMERSET CORPORATE BLVD.
BRIDGEWATER, NEW JERSEY 08807-0911**

Please record your model and serial number and your date and location of Purchase below for your records. Keep this information with your proof of purchase (bill of sale) in case your Product requires service.

Model # _____

Serial # _____

Date of purchase: _____

Store where purchased: _____

Location of store: _____

Important: We recommend that you keep all original packing materials, in the event you ship this product.

Save Time - Register On-Line!

Don't stand in line at the post office or worry about lost mail. Visit us on-line at

www.registermybrother.com

Your product will immediately be registered in our database and you can be on your way!

Also, while you're there, look for contests and other exciting information!

1 Getting Started

General Description

Top view & bottom view

Top view

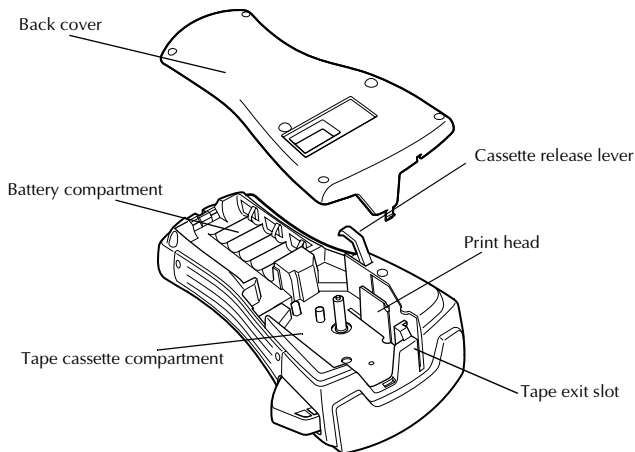
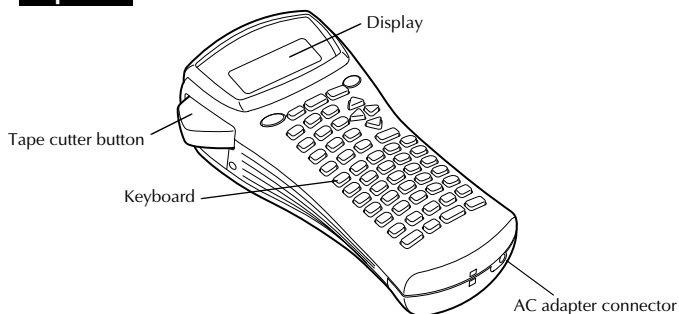

Bottom view

Keyboard & LCD display

PT-1400

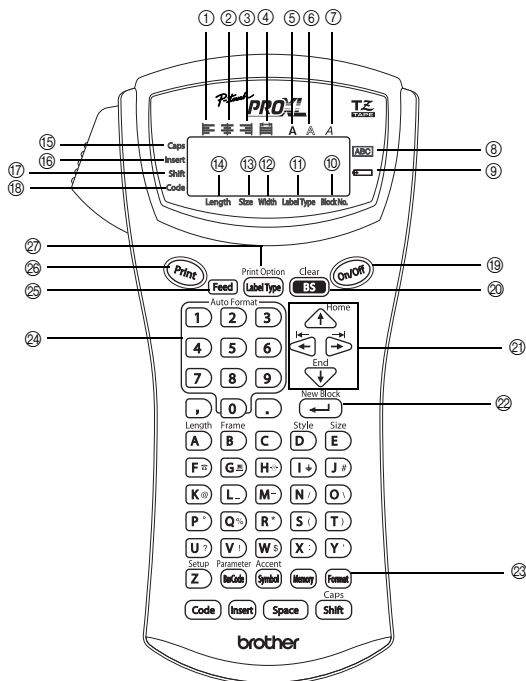

- | | |
|--------------------------------------|---------------------------------|
| ① Left text alignment (page 28) | ⑮ Caps mode (page 15) |
| ② Center text alignment (page 28) | ⑯ Insert mode (page 16) |
| ③ Right text alignment (page 28) | ⑰ Shift mode (page 15) |
| ④ Justified text alignment (page 28) | ⑱ Code mode (page 15) |
| ⑤ Bold text style (page 27) | ⑲ Power key (page 8) |
| ⑥ Outline text style (page 27) | ⑳ Backspace key (pages 14 & 17) |
| ⑦ Italic text style (page 27) | ㉑ Arrow keys (page 14) |
| ⑧ Frame (page 24) | ㉒ Return key (pages 14 & 16) |
| ⑨ Low battery (page 5) | ㉓ Global format key (pages 25) |
| ⑩ Block number (page 16) | ㉔ Auto Format keys (page 29) |
| ⑪ Label Type setting (page 9) | ㉕ Feed key (page 30) |
| ⑫ Width setting (page 26) | ㉖ Print key (page 30) |
| ⑬ Size setting (pages 25 & 26) | ㉗ Label Type (page 9) |
| ⑭ Length setting (page 23) | |

General Precautions

- Use only **Brother TZ tapes with this machine. Do not use tapes that do not have the  mark.**
- Do not pull on the tape being fed from the P-touch, otherwise the tape cassette may be damaged.
- Avoid using the machine in extremely dusty places. Keep it out of both direct sunlight and rain.
- Do not expose the machine to extremely high temperatures or high humidity. Never leave it on the dashboard or in the back of your car.
- Do not store tape cassettes where they would be exposed to direct sunlight, high humidity or dust.
- Do not leave any rubber or vinyl on the machine for an extended period of time, otherwise the machine may be stained.
- Do not clean the machine with alcohol or other organic solvents. Only use a soft, dry cloth.
- Do not put any foreign objects into or heavy objects on the machine.
- To avoid injuries, do not touch the cutter's edge.
- Use only the AC adapter designed exclusively for this machine. Use of any other adapter will void the warranty.
- Do not try to disassemble the AC adapter.
- When the machine is not to be used for a long period of time, disconnect the AC adapter, and remove the batteries to prevent them from leaking and damaging the machine.
- Use six AA alkaline or rechargeable (Ni-Cd or Ni-MH) batteries.
- Never try to disassemble the P-touch.

Batteries & Tape Cassettes

This machine has been designed to allow you to change the batteries and tape cassettes quickly and easily. With batteries installed, this compact and portable machine can be used anywhere. TZ tape cassettes are available for this machine in a wide variety of types, colors and sizes, enabling you to make distinctive color-coded and stylized labels.

Installing batteries and a tape cassette

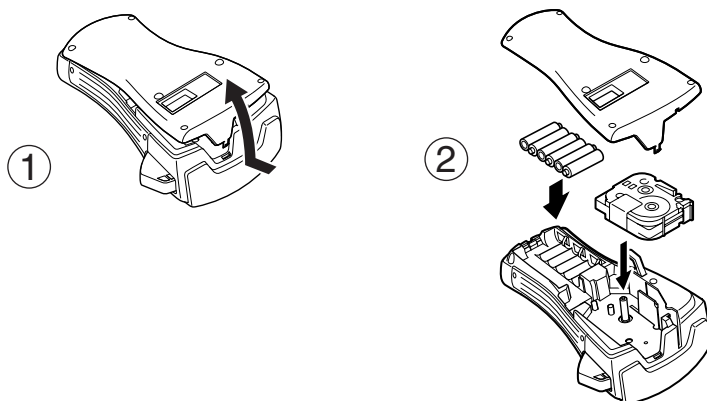

Notes on batteries

- ☛ **This P-touch requires six AA-size batteries. Rechargeable (Ni-Cd or Ni-MH) batteries can be used instead of six alkaline batteries.**
- ☛ The rechargeable batteries cannot be recharged by leaving them in the P-touch with the AC adapter connected. Instead, recharge the batteries by using a battery charger designed specifically for the type of batteries used. For more details on the rechargeable batteries, refer to the instructions provided with them.
- ☛ Do not use any of the following, otherwise battery leakage or damage may occur.
 - Manganese batteries
 - A combination of new and used batteries
 - A combination of batteries of different types (alkaline, Ni-Cd and Ni-MH), different manufacturers or different models
 - A combination of recharged and uncharged batteries

- ❗ Make sure that the batteries are inserted so that their poles point in the correct direction. With batteries installed, the P-touch determines the remaining battery charge during printing and feeding. If a low battery charge is detected, the low battery indicator () comes on. When this occurs, be sure to replace the batteries. The low battery indicator may not come on in some operating conditions.
- ❗ Before replacing the batteries, make sure that the P-touch is turned off. In addition, when replacing the batteries, insert the new ones within five minutes of removing the old ones, otherwise the text shown in the display and any text stored in the memory will be lost.
- ❗ If you do not intend to use this P-touch for an extended period of time, remove the batteries. When the power is disconnected, all text shown in the display and stored in the memory will be lost.
- ❗ Since the enclosed batteries begin discharging from the time that the unit is shipped from the factory, their life span may not meet specifications, depending on when the unit is put into use.

Notes on tape cassettes

- ❗ Before installing the tape cassette, make sure that the end of the tape feeds under the tape guides. If the tape cassette to be installed has an ink ribbon and the ink ribbon is loose, use your finger to wind the toothed wheel in the direction of the arrow on the cassette until there is no slack in the ribbon.

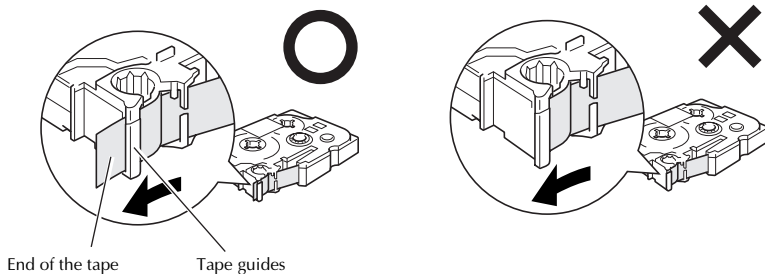

- ❗ When inserting the tape cassette, make sure that the inner ribbon does not catch on the corner of the metal guide.
- ❗ After installing a tape cassette, press  once to remove any slack in the tape, and then press in on the tape cutter button to cut off the excess tape.
- ❗ Always cut off the tape before removing it from the machine. If the tape is pulled on before being cut off, the tape cassette may be damaged.

Extra Strength Adhesive Tape

- For textured, rough, or slippery surface, we recommend using Extra Strength Adhesive Tape.
- Although the instruction sheet included with the Extra Strength Adhesive Tape cassette recommends cutting the tape with scissors, the tape cutter that this P-touch is equipped with is able to cut Extra Strength Adhesive Tape.**

Flexible ID Tape

- For applications that require more flexible labels, such as around sharp bends and cylindrical objects, we recommend using Flexible ID Tape.
- Labels made with Flexible ID Tape are not designed for use as electrical insulation.
- When wrapping labels around cylindrical objects, the diameter of the object should be at least 1/8" (3 mm), otherwise the label should be wrapped as a flag and the **FLAG** Label Type mode should be used. In addition, the overlapping ends of the label or the label flag should be at least 3/16" (5 mm).
- The label may peel off cylindrical objects if the object is bent after the label is affixed.

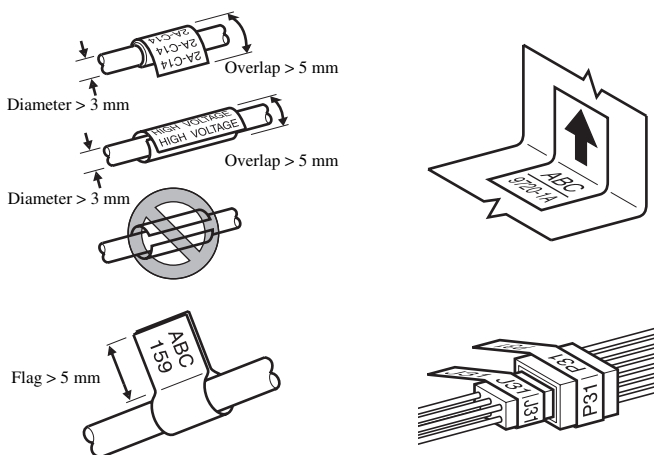

Cleaning

Occasionally, certain parts of the P-touch may need to be cleaned. Dust or dirt may become attached to the P-touch's print head and rollers, particularly when the unit is used outdoors or in a very dusty environment. With use, the tape cutter may become covered with adhesive, making it difficult to cut the tape.

Cleaning the print head, rollers and tape cutter

- ⚠ Before cleaning the print head and rollers, press **On/Off** to turn off the P-touch, and then remove the batteries and disconnect the optional AC adapter.
- ⚠ Be extremely careful not to touch the cutter blades with your fingers.

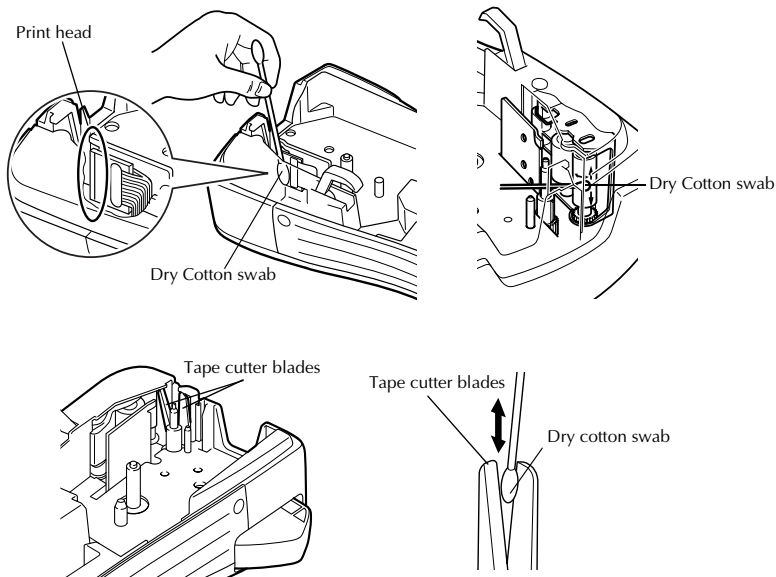

Notes on cleaning the print head & rollers

- ⚠ If a blank horizontal streak appears through the label text, clean the machine's print head.
- ⚠ The print head can be cleaned more easily if the optional print head cleaning cassette (TZ-CL4) is used.

Notes on cleaning the tape cutter

- ☞ If the tape cannot be cut correctly, clean the tape cutter blades.

Optional AC Adapter

When printing a large number of labels or labels that contain a large amount of text, it may be useful to connect the P-touch to a standard electrical outlet using the optional AC adapter.

Connecting the AC adapter

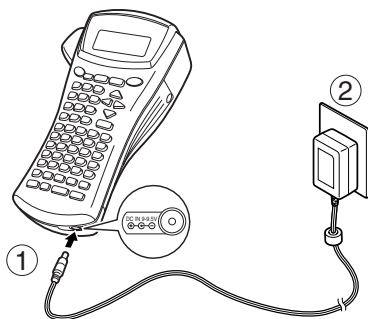

Notes on the AC adapter

- ☞ Only use the AC adapter designed exclusively for this machine.
- ☞ Disconnect the AC adapter if you do not intend to use this P-touch for an extended period of time. When the power is disconnected, all text shown in the display and stored in the memory will be lost.

Turning the P-touch On/Off

Press **On/Off** to turn on or turn off the P-touch.

If batteries are installed or the P-touch has remained plugged in using the AC adapter, the previous session's text is displayed when the P-touch is turned on again. This feature allows you to stop work on a label, turn off the machine, and return to it later without having to re-enter the text.

Regardless of whether the P-touch is being operated from batteries or the AC adapter, the machine will automatically turn off if no key is pressed or no operation is performed for 5 minutes.

2 Label Type Modes

Selecting a Label Type Mode

Pressing ^{Print Option} (Label Type) allows you to select one of the two regular modes for designing and printing your own custom labels, or any of the five special modes available for printing labels pre-formatted for identifying patch panels, cables, connectors and other components.

- 1 Press ^{Print Option} (Label Type).
- 2 Press ^{Home} (↑) or ^{End} (↓) (or continue pressing ^{Print Option} (Label Type)) until the desired mode is displayed. (For details on each Label Type mode, refer to the sections below.)
- 3 Press ^{New Block} (←) to apply the selected Label Type mode.
 - If **NORMAL** or **VERTICAL** was selected, continue entering the label text as described in chapter 3, *Basic Functions*.
 - If **ROTATE**, **ROT-REP**, **PORT**, **PANEL**, or **FLAG** was selected, continue with the following steps.
- 4 Press [←] (←) or [→] (→) until the desired parameter is displayed.
- 5 Press ^{Home} (↑) or ^{End} (↓) until the desired setting is displayed (or use the number keys to type in the desired setting).
- 6 Press ^{New Block} (←) to apply the selected settings.
- 7 Type the text for each label in a separate text block.
- 8 Print the labels.
 - To print a single copy of each label, press ^(Print) (Print).
 - To print multiple copies or several copies while increasing certain characters, or to print using any other special printing function, press ^(Code) (Code), then ^{Print Option} (Label Type) and choose your options. (For details, refer to *Using special printing functions* on page 31.)

Normal and Vertical Modes

Labels printed using the **Normal** and **Vertical** Label Type modes can be formatted and printed to fit any need.

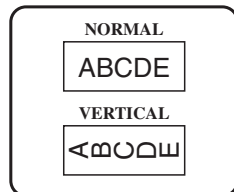

After selecting the Label Type mode **NORMAL** or **VERTICAL**, the label text can be entered, formatted, printed and cut as usual. With the **Normal** Label Type mode, the entered text is printed horizontally along the label. With the **Vertical** Label Type mode, the entered text is printed vertically along the label.

Rotate Mode and Rotate & Repeat Mode

Labels printed using these Label Type modes can be wrapped around cables and wires to mark them. With both of these modes, the text is rotated 90° counterclockwise and each text block printed on a separate label as shown below. With the Rotate & Repeat mode, the text is printed repeatedly along the length of the label so that it can easily be read from any angle.

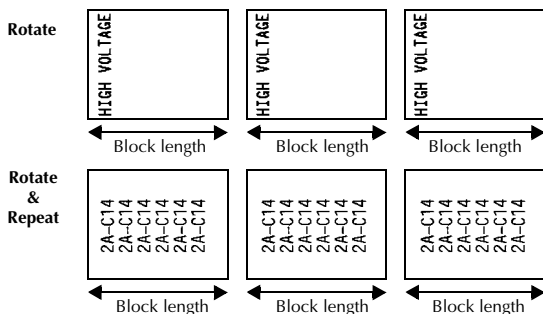
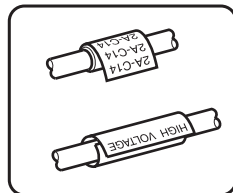

After selecting the **ROTATE** or **ROT-REP** Label Type mode, specify the length of each label and a frame style if desired.

- **BLK LEN.** (block length): 0.80" to 8.00" (20 to 200 mm)
Default: 1.20" (30 mm)
- **FRAME:** OFF, 1, 2, 3, 4
Default: OFF

- ☞ A single block of text can contain a maximum of 7 text lines, and with the **ROT-REP** Label Type mode, only the text lines that fit within the label are printed.
- ☞ For labels to be attached to cables and wires, we recommend using Flexible ID Tape. When wrapping Flexible ID Tape around cylindrical objects, the diameter of the object should be at least 1/8" (3 mm), otherwise the **FLAG** Label Type mode should be used. In addition, the overlapping ends of the label or the flag length should be at least 3/16" (5 mm).

Flag Mode

Labels printed using this Label Type mode can be wrapped around cable or wire with the ends stuck together to form a flag. With the **FLAG** Label Type mode, each block of text is printed at both ends of separate labels. The length of the unprinted part of this label is equal to the circumference of the cable or wire. In addition, the text can be printed horizontally or rotated 90°.

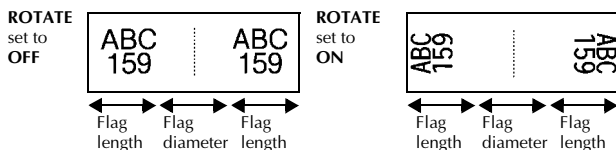
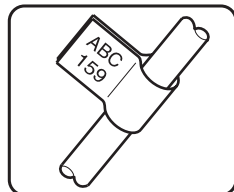

After selecting the **FLAG** Label Type mode, specify the length and diameter of the flag, a frame style if desired, and whether or not to rotate the text.

- **FLAG ϕ** (flag diameter): 0.00" to 4.00" (0 to 100 mm)
Default: 0.25" (7 mm)
- **FLAG LEN** (flag length): 0.40" to 8.00" (10 to 200 mm)
Default: 1.20" (30 mm)
- **FRAME:** **OFF**, 1, 2, 3, 4
Default: **OFF**
- **ROTATE:** **OFF**, **ON**
Default: **OFF**

- ☞ A single block of text can contain a maximum of 7 text lines.
- ☞ For labels to be attached to cables and wires, we recommend using Flexible ID Tape. To wrap Flexible ID Tape around cylindrical objects, use the **FLAG** Label Type mode when the diameter of the object is less than 1/8" (3 mm). In addition, the flag length should be at least 3/16" (5 mm).

Port & Panel Modes

Labels printed using these Label Type modes can be used to identify various components or panels.

With the **Port** Label Type mode, each block of the text is printed on a separate label, making these labels useful for identifying different components or ports that are not equally spaced.

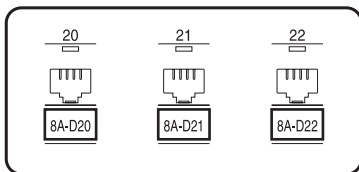

With the **Panel** Label Type mode, all blocks of the text are evenly spaced on a single label, making this label useful for a row of equally spaced switches, fuses or connectors on a patch panel. In addition, the text blocks can be printed in the order that they were typed in or in the opposite order.

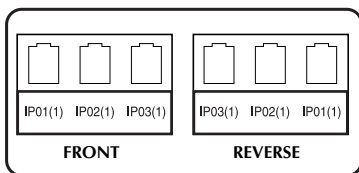

Port

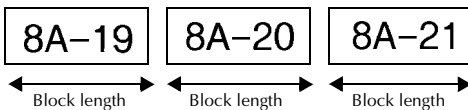

Panel
(PRINT set
to FRONT)

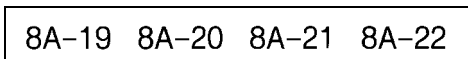

Panel
(PRINT set
to REVERSE)

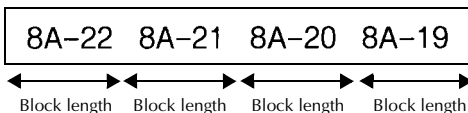

After selecting the **PORT** or **PANEL** Label Type mode, specify the length of each text block or label, and select a frame style if desired. For the **PANEL** Label Type mode, select whether the text blocks are printed in the order that they were typed in or in the reverse order.

- **BLK LEN.** (block length): * For the **PORT** Label Type mode:
0.80" to 8.00" (20 to 200 mm)
Default: 1.20" (30 mm)
* For the **PANEL** Label Type mode:
0.25" to 8.00" (6 to 200 mm)
Default: 1.20" (30 mm)
- **FRAME:** * For the **PORT** Label Type mode:
OFF, 1 , 2 , 3 , 4
Default: **OFF**
* For the **PANEL** Label Type mode:
OFF, 1 , 2 , 3 ,
4 , 5 , 6 ,
7 , 8 , 9
Default: **OFF**
- **PRINT** (print order): **FRONT, REVERSE**
Default: **FRONT**





- ☞ For these types of labels, we recommend using Extra Strength Adhesive Tape.
- ☞ The **PRINT** parameter is only available with the **PANEL** Label Type mode.
- ☞ **Using the Numbering function with the PANEL Label Type mode makes it easy to create a single label of multiple blocks containing incremental characters, which can be used, for example, to label patch panels as shown above.**

- 1 Choose Label Type **PANEL**.
- 2 Type in one block of text.
- 3 Use the numbering function under to choose the corresponding field to be incremented and the number of sequential labels to be printed.

3 *Basic Functions*

Performing Basic Operations

Choosing functions, parameters, settings and groups

- If “◀▶” appears, press  to select the previous item or  to select the next item.
- If “▲▼” appears, press  to select the previous item or  to select the next item.

Choosing the default setting

- To select the default setting of a function or parameter, press .

Confirming a choice

- To select an item from a list, to apply a selected setting, or to answer “yes”, press .



Cancelling a choice



- To quit a function and return to the previous display without changing the text, or to answer “no”, press .



Inputting Label Data



Entering and editing text

Entering characters

- To type a lowercase letter, a number, a comma or a period, simply press the key for that character.
- To type an uppercase letter, press  to enter Shift mode, and then press the applicable letter.
- To type uppercase letters continuously, press , then  to enter Caps mode, and then type.

 To exit Shift mode without typing a letter, press .

 To exit Caps mode, press , then .













 To type a lowercase letter in Caps mode, press , then the applicable letter.





Entering spaces

- To add a blank space to the text, press .

Moving the cursor

Move the cursor in order to review and edit the text, or you can select the various functions and settings.

- To move the cursor left, right, up or down, press , ,  or .
- To move the cursor to the beginning of the current line of text, press , then .
- To move the cursor to the end of the current line of text, press , then .
- To move the cursor to the beginning of the entered text, press , then .
- To move the cursor to the end of the entered text, press , then .

 To move the cursor several characters or lines at once, hold down , ,  or .

Adding a new line of text



- To end the current line of text and start a new one, press . “↵” appears at the end of the line.

☞ The number of text lines that can be printed depends on the width of the tape.

Tape Width	Maximum Number of Lines That Can Be Printed
1/4" (6 mm)	2
3/8" (9 mm)	2
1/2" (12 mm)	3
3/4" (18 mm)	5
1" (24 mm)	7

☞ The line number on the display indicates the line number of the text block.

Adding a new text block

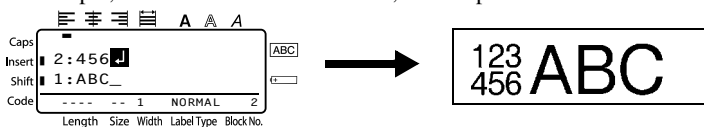

- To create a new text block so that one section of the text can have a different number of lines than another, press , then . “↵” appears at the end of the block.

For example, text entered as shown below, will be printed as follows.







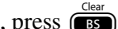

- ☞ A single label can only contain a maximum of fifty text blocks.
- ☞ The number of the block that the cursor is in is indicated at the bottom of the display.
- ☞ All text blocks have the same formatting features.
- ☞ While trying to print a large amount of data at one time, some outputted labels may be blank. For example, when printing 50 records, the maximum number of characters that can be printed at one time is limited to approximately 200.

Inserting text

- To insert the text that you type at the cursor's current position, make sure that the **Insert** indicator is displayed. Otherwise, press  to enter **Insert** mode.
- To replace the text at the cursor's current position instead of inserting it, press  to exit **Insert** mode.

Deleting text





- To remove characters to the left of the cursor's current position, press   until all of the characters that you wish to delete are removed.
- To delete all of the text:
 - Press , then .
 - Press  or  to select either **TEXT ONLY** (to erase just the text) or **TEXT&FORMAT** (to erase all of the text and return all formatting functions to their default settings).
 - Press .





Entering an accented character

There are various accented characters available with the Accent function.

The following accented characters are available.

Letter	Accented Characters						Letter	Accented Characters					
	0	1	2	3	4	5		0	1	2	3	4	5
A	À	Á	Ä	Â	Ã	Æ	a	à	á	ä	â	ã	æ
C	Ç						c	ç					
E	È	É	Ë	Ê	Ë		e	è	é	ë	ê	ë	
I	Í	Ï	Î				i	í	ï	î			
N	Ñ						n	ñ					
O	Ó	Ö	Ô	Õ			o	ó	ö	ô	õ		
U	Ù	Ú	Û	Û			u	ù	ú	ü	û		

- Press , then . The message "ACCENT a-u/A-U?" appears.
- Press the key of the letter in the desired accented character until the desired character is selected.
- Add the accented character(s) to the text.
 - To add a single accented character or the last one in a series, skip to step **5**.
 - To add a series of accented characters to the text, press , then .
- For each additional accented character, repeat steps **2** and **3**.
- Press .

- To type in an uppercase accented character, press  (or press , then  to enter Caps mode) before pressing the letter key.
- An accented character can also be selected by typing in the corresponding code from the table above. For example, typing “A2”, then pressing  adds “Ä” to the text.

Entering a bar code

The **Bar Code** function allows bar codes to be printed as part of labels.







- Since this machine is not specifically designed for special bar code label-making, some bar code readers may not be able to read the labels.
- Bar code readers may not be able to read bar codes printed with certain ink colors on certain label tape colors. For best results, print barcode labels in black on white tape.

In addition, the various bar code parameters enable you to create more customized bar codes.



Parameter	Settings
PROTOCOL	CODE 39, I-2/5, EAN13, EAN8, UPC-A, UPC-E, CODABAR, EAN128, CODE128
WIDTH (bar width)	MEDIUM, SMALL, LARGE
UNDER# (numbers printed below bar code)	ON, OFF
CHECK DIGIT	OFF, ON









- The **CHECK DIGIT** parameter is only available with the **CODE 39, I-2/5** and **CODABAR** protocols.

Setting bar code parameters

- Press , then .
- Press  or  until the parameter that you wish to change is displayed.
- Press  or  until the desired setting is displayed.
- Repeat steps **2** and **3** until all parameters are set as you wish.
- Press .

Entering bar code data

- 1 Press .
- 2 Type in the new bar code data or edit the old data.
- 3 Press  to add the bar code to the text.

-  To add special characters to the bar code data (only with protocols **CODE39**, **CODABAR**, **EAN128** or **CODE128**), position the cursor below the character immediately to the right of where you wish to add the special character, and then press . Press  or  until the desired special character is displayed, and then press  to add the character to the data. (Refer to the tables below for a list of the special characters that are available.)
-  To change the data or **WIDTH** or **UNDER#** parameter settings of a bar code that has already been added to the text, position the cursor below the bar code mark (), and then press , then .

The following special characters can only be added to bar codes created using protocol **CODE39** or **CODABAR**.

CODE39

CODABAR

Symbol	Character	Symbol	Character
0	-	4	/
1	.	5	+
2	(SPACE)	6	%
3	\$		







Symbol	Character	Symbol	Character
0	-	3	/
1	\$	4	.
2	:	5	+

The following special characters can only be added to bar codes created using protocols EAN128 and CODE128.



Symbol	Character	Symbol	Character	Symbol	Character	Symbol	Character
0	(SPACE)	18	<	36	BEL	54	EM
1	!	19	=	37	BS	55	SUB
2	”	20	>	38	HT	56	ESC
3	#	21	?	39	LF	57	{
4	\$	22	@	40	VT	58	FS
5	%	23	[41	FF	59	
6	&	24	\	42	CR	60	GS
7	'	25]	43	SO	61	}
8	(26	^	44	SI	62	RS
9)	27	_	45	DLE	63	~
10	*	28	NUL	46	DC1	64	US
11	+	29	`	47	DC2	65	DEL
12	,	30	SOH	48	DC3	66	FNC3
13	-	31	STX	49	DC4	67	FNC2
14	.	32	ETX	50	NAK	68	FNC4
15	/	33	EOT	51	SYN	69	FNC1
16	:	34	ENQ	52	ETB		
17	;	35	ACK	53	CAN		

Entering a symbol

There are 147 symbols and pictures available with the Symbol function.

- 1 Press . The last category used is displayed.
- 2 Press  or  to select the desired category.
- 3 Press  or  until the desired symbol is selected.
- 4 Add the symbol(s) to the text.
 - To add a single symbol or the last one in a series, skip to step 6.
 - To add a series of symbols to the text, press , then .
- 5 For each additional symbol, repeat steps 2 through 4.

6 Press .

- ☞ A symbol can also be selected by typing in the corresponding code from the table below. For example, typing “A02”, then pressing  adds “?” to the text.
- ☞ Some symbols are printed in color on the keypad. To use a symbol on a key, press  to enter Code mode, and then press the key for the symbol.

The following symbols are available.

Category	Symbols									
A PUNCTUATION	.	,	?	!	”	'	:	;	—	—
	00	01	02	03	04	05	06	07	08	09
	\	/	&	;	¡	~	§	•		
	10	11	12	13	14	15	16	17		
B BUSINESS	@	#	%	®	©	™				
	00	01	02	03	04	05				
C MATHEMATICS	+	—	×	*	±	=	÷			
	00	01	02	03	04	05	06			
D BRACKET	()	[]	<	>	《	》		
	00	01	02	03	04	05	06	07		
E ARROW	→	←	↑	↓	➔	➔	⬆	⬇	☞	☞
	00	01	02	03	04	05	06	07	08	09
F UNIT	°	\$	¥	£	€	¢	Fr	f	φ	
	00	01	02	03	04	05	06	07	08	
G INTERNATIONAL CHARACTERS	ā	ā	ß	SS	ɑ	β	γ	δ	μ	Ω
	00	01	02	03	04	05	06	07	08	09
	Ð	ð	Þ	þ	ij					
	10	11	12	13	14					

Category		Symbols									
H	NUMBER	1/2	1/3	1/4	0	1	2	1	2		
		00	01	02	03	04	05	06	07		
I	PICTOGRAPH	★	○	●	□	△	◆				
		00	01	02	03	04	05				
J	ELECTRICAL / ELECTRONIC										
		00	01	02	03	04	05	06	07	08	09
		10	11	12	13	14	15	16	17	18	19
		20	21	22	23	24	25	26	27	28	29
30	31	32	33	34	35	36	37	38	39		
40	41	42									
K	PROHIBITION										
		00	01	02							
L	WARNING										
		00	01	02	03	04	05	06			
M	COMMUNICATIONS										
		00	01	02							
N	OTHERS										
		00	01	02	03						
Z	PERSONAL CATEGORY	*A maximum of 16 most recently selected symbols are automatically saved in the PERSONAL symbol category.									

Once the **PERSONAL** symbol category becomes full, newly selected symbols will overwrite older ones unless the Symbol Save function is set to **OFF**. (Refer to *Specifying if the PERSONAL symbol category is continually updated* on page 39.)

Formatting the Label

Specifying a label length

The length of the label can be specified as follows.

- 1 Press **Code**, then **A**^{Length}.
- 2 Press **←** or **→** until **LENGTH** is displayed.
- 3 Press **↑**^{Home} or **↓**^{End} until the desired label length is displayed (or use the number keys to type in the desired setting).
- 4 Press **←**^{New Block}.

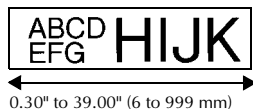



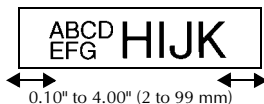

Specifying a margin size

The size of the margins for the left and right sides of the text can be specified.















- 1 Press **Code**, then **A**^{Length}.
- 2 Press **←** or **→** until **MARGIN** is displayed.
- 3 Press **↑**^{Home} or **↓**^{End} until the desired margin setting is displayed (or use the number keys to margin type in the desired setting).
- 4 Press **←**^{New Block}.



Framing the text

- 1 Press , then .
- 2 Press  or  until the desired frame setting is displayed.
- 3 Press . The selected setting is applied to the entire text.

The following frame styles are available.

Frame Setting	Sample	Frame Setting	Sample
1		8	
2		9	
3		10	
4		11	
5		12	
6		13	
7		14	

Specifying the character size

The character size can be specified for all text in the label or only for the text in the line that the cursor is in.

☞ With the default character size setting **AUTO**, the largest possible text size is automatically selected depending on the width of the tape and the number of lines in the text.

Formatting the character size of all text

- 1 Press **Format**.
- 2 Press **←** or **→** until **GLB SIZE** is displayed.
- 3 Press **↑**^{Home} or **↓**^{End} until the desired character size setting is displayed.
- 4 Press **←**^{New Block}. The selected setting is applied to the entire text.

Formatting the character size of a line

- 1 Move the cursor to the line of text whose size you wish to change.
- 2 Press **Code**, then **E**^{Size}.
- 3 Press **↑**^{Home} or **↓**^{End} until the desired character size setting is displayed.
- 4 Press **←**^{New Block}. The selected setting is only applied to the text line that the cursor is positioned in.

☞ Since the text sizes that can be printed depends on the width of the tape, the following table shows the maximum text size that can be used with each tape width.

Tape Width	Maximum Text Size
1/4" (6 mm)	12 points (3 mm)
3/8" (9 mm)	18 points (4 mm)
1/2" (12 mm)	24 points (6 mm)
3/4" (18 mm)	36 points (9 mm)
1" (24 mm)	48 points (12 mm)

☞ With the **AUTO** setting selected and the text in a block consisting of just one line of only uppercase letters (and no accented letters), the text is printed slightly larger than the maximum possible for the tape width.

Specifying the character width

Formatting the width of all text

- 1 Press **Format**.
- 2 Press **←** or **→** until **GLB WIDE** is displayed.
- 3 Press **↑**^{Home} or **↓**^{End} until the desired character width setting is displayed.
- 4 Press **↶**^{New Block}. The selected setting is applied to the entire text.

Formatting the width of a line

- 1 Move the cursor to the line of text whose character width you wish to change.
- 2 Press **Code**, then **E**^{Size}.
- 3 Press **←** or **→** until **WIDTH** is displayed.
- 4 Press **↑**^{Home} or **↓**^{End} until the desired character width setting is displayed.
- 5 Press **↶**^{New Block}. The selected setting is only applied to the text line that the cursor is positioned in.

The following width sizes are available for each text size as shown.

Width Size	NORMAL	NARROW	MINIMUM	WIDE
12 mm (48 points)	ABC	ABC	ABC	ABC
9 mm (36 points)	ABC	ABC	ABC	ABC
6 mm (24 points)	ABC	ABC	ABC	ABC
4 mm (18 points)	ABC	ABC	ABC	ABC
3 mm (12 points)	ABC	ABC	ABC	ABC
2 mm (9 points)	ABC	ABC	ABC	ABC
1 mm (6 points)	ABC	ABC	ABC	ABC

Specifying the character style

Formatting the character style of all text

- 1 Press **Format**.
- 2 Press **←** or **→** until **GLB STYL** is displayed.
- 3 Press **↑** or **↓** until the desired character style setting is displayed.
- 4 Press **↵**. The selected setting is applied to the entire text.







Formatting the character style of a line

- 1 Move the cursor to the line of text whose character style you wish to change.
- 2 Press **Code**, then **D**.
- 3 Press **↑** or **↓** until the desired character style setting is displayed.
- 4 Press **↵**. The selected setting is only applied to the text line that the cursor is positioned in.

The following text styles are available.

Style Setting	Sample	Style Setting	Sample
NORMAL	ABC	ITALIC	<i>ABC</i>
BOLD	ABC	I+BOLD (italic & bold)	<i>ABC</i>
OUTLINE	ABC	I+OUTL (italic & outline)	<i>ABC</i>

Specifying the alignment for all lines in the text

- 1 Press .
- 2 Press  or  until **ALIGN** is displayed.
- 3 Press  or  until the desired setting is displayed.
- 4 Press . The selected setting is applied to the entire text.



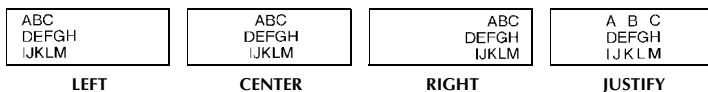





The following alignment settings are available.

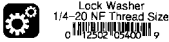

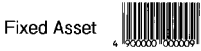

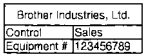
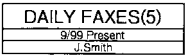
Using the pre-formatted Auto Format templates







Various pre-formatted label templates are available, enabling you to quickly and easily create labels for a variety of applications—from identifying the contents of boxes and file folders to labelling equipment and making name badges and ID tags. After simply selecting one of the ten label templates, type text into each of its fields, and then the label is ready to be printed.

The following label templates are available.







Key	Template Name	Tape Width × Label Length	Template Fields	Sample
1	BIN BOX	3/4" × 2.80" (18 mm × 70 mm)	① SYMBOL? ② TEXT1? ③ TEXT2? ④ BAR CODE?	
2	ASSET1	1" × 3.35" (24 mm × 84 mm)	① TEXT1? ② TEXT2? ③ BAR CODE?	
3	ASSET2	1" × 3.15" (24 mm × 80 mm)	① TEXT? ② BAR CODE?	
4	ASSET3	1" × 1.65" (24 mm × 41 mm)	① TEXT? ② BAR CODE?	
5	ASSET4	1" × 2.25" (24 mm × 56 mm)	① TEXT1? ② TEXT2? ③ TEXT3? ④ TEXT4? ⑤ TEXT5?	
6	ID LABEL	1" × 2.80" (24 mm × 70 mm)	① TEXT1? ② TEXT2? ③ TEXT3?	
7	SIGN	1" × 4.05" (24 mm × 102 mm)	① SYMBOL? ② TEXT1? ③ TEXT2?	
8	BADGE	3/4" × 4.05" (18 mm × 102 mm)	① NAME? ② COMPANY?	
9	FILING	1/2" × 3.55" (12 mm × 89 mm)	① TITLE? ② SUBTITLE?	
0	IC CHIP	3/8" × 1.05" (9 mm × 26 mm)	① TEXT1? ② TEXT2?	

1 Press , then the number key where the template that you wish to use is assigned.

2 Press . The first field for the selected template is displayed.

- 3 Press  or  to display each field, and then type in the text.
- 4
- To print a single copy, press .
 - To print multiple copies, several copies while increasing certain characters, or a mirror image of the text, press , then  . (For details, refer to *Using special printing functions* on page 31.)



☞ Accented characters (page 17), symbols (page 20) and bar codes (page 18) can be entered in the template fields.



☞ To quit using the template, display the last field, and then press  . The Auto Format menu appears. Press  or  until **EXIT** appears, and then press  .





Printing Labels

Previewing the label layout

The **Preview** function allows you to see a sample of the layout of the text.

- To use the print preview, press , then . The length of the current label is indicated in the lower-left corner of the display.

☞ To scroll the print preview left or right, press  or .

☞ To return to the text, press   or  .

Feeding tape

- To feed out 1" (23 mm) of tape, press . The message "FEED" is displayed.

☞ Press  to feed out any leftover printed tape after pressing  to quit printing.

Printing a label

- To print out a label, press . The message "WORKING", then "COPIES" followed by the number of the label being printed is displayed.











☞ To quit printing, press  to turn off the P-touch.

Using special printing functions



Various special printing functions are available that enable you to print multiple copies of labels, print several copies while incrementing the values of certain characters, print specific sections of label text, or print label text as a mirror image.

Printing multiple copies of a label

The Repeat Printing function allows you to print up to 99 copies of the same text.

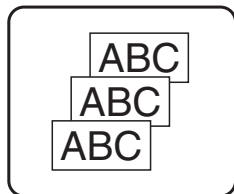
- 1 Press , then .
- 2 Press  or  until **COPIES** is displayed.
- 3 Press  or  until the desired number of copies is displayed (or use the number keys to type in the desired setting).
- 4 Press  (or ). **START** appears in the Print Option menu.
- 5 Press  (or ) to begin printing the specified number of copies. The number of each copy is displayed while it is being printed.











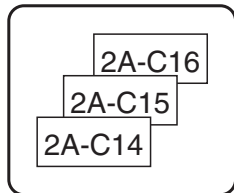









- ☞ If the Cut function is set to **1** or **3**, the message “CUT TAPE TO CONTINUE” appears after each label is printed. Press the tape cutter button to cut off the label and continue printing.
- ☞ Be sure to cut the tape within 5 minutes from the time that the message appears.
- ☞ For the different options available for cutting the tape, refer to *Selecting how tape is fed and cut* on page 37.
- ☞ To specify settings for additional Print Option functions, instead of continuing with step **5**, press  or  until **CONTINUE** is displayed in the Print Option menu, and then press .

Printing multiple copies with incremental characters



The Numbering function can be used to print several copies of the same text while incrementing the values of certain characters (letters, numbers or bar code data) after each label is printed. This type of automatic incrementation is very useful when printing serial number labels, production control labels or other labels requiring ascending codes.

- 1 Press , then .















- 2 Press  or  until **NUMBER** is displayed.
- 3 Press  or  until the desired number of copies is displayed (or use the number keys to type in the desired setting).
- 4 Press . The message “START?” appears. (To specify only the character at the cursor’s current position as the numbering field, press , and then skip to step 9.)
- 5 Press , ,  or  until the first character that you wish to include in the numbering field is flashing.
- 6 Press . The message “END?” appears.
- 7 Press , ,  or  until the last character that you wish to include in the numbering field is flashing.
- 8 Press . **START** appears in the Print Option menu.
- 9 Press  (or ) to begin printing the specified number of labels. The number of each copy is displayed while it is being printed.

- ☞ If the Cut function is set to **1** or **3**, the message “CUT TAPE TO CONTINUE” appears after each label is printed. Press the tape cutter button to cut off the label and continue printing.
- ☞ Be sure to cut the tape within 5 minutes from the time that the message appears.
- ☞ For the different options available for cutting the tape, refer to *Selecting how tape is fed and cut* on page 37.
- ☞ Letters and numbers increase as shown below.
 - 0 → 1 → ...9 → 0 → ...
 - A → B → ...Z → A → ...
 - a → b → ...z → a → ...
 - A0 → A1 → ...A9 → B0 → ...
 Spaces (shown as underlines “_” in the examples below) can be used to adjust the space between characters or to control the number of digits that are printed.
 - _Z → AA → ...ZZ → AA → ...
 - _9 → 10 → ...99 → 00 → ...
 - 1_9 → 2_0 → ...9_9 → 0_0 → ...
- ☞ Only one numbering field can be selected from any text.
- ☞ A numbering field must be located entirely within one line of text of a single block.
- ☞ A maximum of five characters can be selected for the numbering field.
- ☞ If you include a non-alphanumeric character such as a symbol in the numbering field, only the letters and numbers in the numbering field will be increased when the labels are printed, or just one label will be printed if the field only contains a non-alphanumeric character.



- To specify settings for additional Print Option functions, instead of continuing with step 9, press  or  until **CONTINUE** is displayed in the Print Option menu, and then press .
- Increments can be made to one block of text. If a bar code is selected as the incremental (numbering) field in step 5, no other block of text can be incremented.

Printing a range of text blocks

The Block Printing function enables you to select the range of text blocks to print.

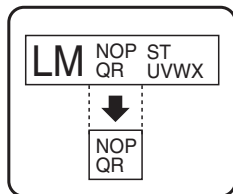



- Press , then .
- Press  or  until the first number in the range displayed below **BLOCK NO.** is flashing.
- Press  or  until the desired block number is displayed (or use the number keys to type in the desired setting).
- Press  so that the second number in the range displayed below **BLOCK NO.** is flashing.
- Press  or  until the desired block number is displayed (or use the number keys to type in the desired setting).
- Press  (or ). **START** appears in the Print Option menu.
- Press  (or ) to begin printing the specified number of labels. The number of each copy is displayed while it is being printed.









- To specify settings for additional Print Option functions, instead of continuing with step 7, press  or  until **CONTINUE** is displayed in the Print Option menu, and then press .

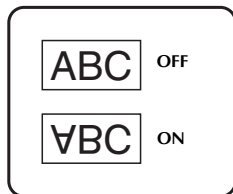

Printing mirrored labels

This function prints your label so that the text can be read from the adhesive side of the tape. If mirror-printed labels are attached to glass or some other transparent material, they can be read correctly from the opposite side.

- Press , then .
- Press  or  until **MIRROR** is displayed.



- 3 Press  or  until **ON** is displayed.
- 4 Press  (or ). **START** appears in the Print Option menu.
- 5 Press  (or ) to begin printing the specified number of labels. The number of each copy is displayed while it is being printed.

- ☞ When using the Mirror Printing function, the text should be printed on clear tape.
- ☞ To specify settings for additional Print Option functions, instead of continuing with step 5, press  or  until **CONTINUE** is displayed in the Print Option menu, and then press .

Combining special printing functions

Many of the special printing functions can be combined, depending on various conditions, such as which Label Type mode is selected or whether a template is being used. For example, by combining the operations for the Repeat Printing function and the Numbering function to print two copies of a label with “1” selected as the numbering field and three increments, the labels shown above will be printed.

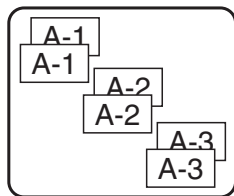







- ☞ For details on the various special printing functions, refer to the corresponding section above.

Storing and Recalling Files



Frequently used label text along with its formatting can be stored in the memory and easily recalled so that it can be edited and quickly printed. When each text file is stored, it is given a number to make recalling it easier. Up to 10 text files or approximately 2,000 characters can be stored in the memory.

Since a copy of the stored text file is recalled when the Recall function is used, the text can be edited or printed without changing the originally stored file. When a file is no longer needed or more space is necessary, the Clear function can be used to delete text files.

Storing label text

- 1 Press .
- 2 Press  or  until **STORE** is displayed.
- 3 Press .
- 4 Press  or  until the file number where you wish to store the text is displayed.
- 5 Press .

☞ If the maximum number of characters has already been stored, the error message “MEMORY FULL!” appears in the display. If this occurs, an existing text file must be deleted before the new one can be stored.

☞ If a file is already stored under the selected file number, the message “OVERWRITE?” appears in the display. To overwrite the stored file with the new one, press . To go back and choose another file number without overwriting the text file, press  (BS), and then select a different file number.

Recalling text that has been stored

- 1 Press **Memory**.
- 2 Press **Home** or **End** until **RECALL** is displayed.
- 3 Press **New Block**.
- 4 Press **Home** or **End** until the file number containing the text that you wish to recall is displayed.
- 5 Press **New Block**. Any text previously entered in the display is erased and the text stored under the selected file number is recalled into the display.

☞ To view other parts of the selected text file, press **Left Arrow** or **Right Arrow**.

Deleting text that has been stored

- 1 Press **Memory**.
- 2 Press **Home** or **End** until **CLEAR** is displayed.
- 3 Press **New Block**.
- 4 Press **Home** or **End** until the file number containing the text that you wish to delete is displayed.
- 5 Select the file(s) to be deleted.
 - To delete a single file, skip to step 6.
 - To select multiple files, press **Space**. The current file number is highlighted. Continue selecting text files by repeating step 4, then pressing **Space** until all files that you wish to delete are selected.
 - To delete all files, press **Code**, then **Space**.
- 6 Press **New Block**. The message “OK TO CLEAR?” (or “CLEAR ALL?” if all files were selected) appears.
- 7 Press **New Block**. The text stored in the selected files is deleted.

☞ If you do not wish to delete the selected text file(s), press **Clear** **BS** instead of **New Block** in step 7.

☞ To view other parts of the selected text file, press **Left Arrow** or **Right Arrow**.

☞ To remove a text file from those that are to be deleted, display the text file, and then press **Space** so that the file number is no longer highlighted.

4 Machine Adjustments

Various functions are available for changing and adjusting the operation of the P-touch.

Selecting how tape is fed and cut

The **Cut** function enables you to specify how the tape is fed out after it is printed. The settings of the Cut function consist of combinations of two different cut methods:

cut-pause (where the machine stops printing so the label can be cut) and chain printing (where the last copy is not fed out to be cut, reducing the amount of tape that is wasted).

Chain printing is an economical function designed to help eliminate “wasted tape” at the beginning of labels. Without chain printing, the excess from the previous printing session is cut before the first label in the current session is printed. However, if a setting using chain printing is selected, the last label in the previous session remains in the machine (is not fed out), so that the next label can be printed without wasting tape. When the last label is printed, press **Feed** to feed the chain of labels, and then press the tape cutter button to cut it.

The following settings are available: (The default setting is **1**.)

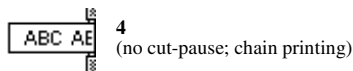
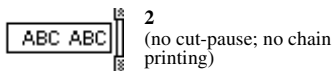
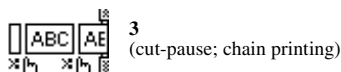
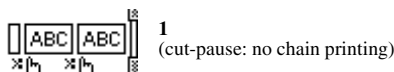

- 1 Press **Code**, then **Setup** (Z).
- 2 Press **Left Arrow** or **Right Arrow** until **CUT** is displayed.
- 3 Press **Home** (up arrow) or **End** (down arrow) until the desired setting is displayed, and then press **New Block** (left arrow).

After printing with the **Cut** function set to **3** or **4**, press **Feed** to feed the tape, and then press the tape cutter button to cut it.

Adjusting the display contrast

The display can be made lighter or darker by selecting a setting between **-2** and **+2**. (The default setting is **0**.) Select a higher value to increase the contrast (make the display darker). Select a lower value to decrease the contrast (make the display lighter).

- 1 Press **Code**, then **Setup** **Z**.
- 2 Press **←** or **→** until **CONTRAST** is displayed.
- 3 Press **Home** **↑** or **End** **↓** until the desired setting is displayed, and then press **New Block** **←**.

Setting the Auto Reduction function

With the Auto Reduction function, you can select whether the text width (**TEXT WIDTH**) or the text size (**TEXT SIZE**) will be reduced if text that is set to the **AUTO** Size setting is too large for the specified label length. (The default setting is **TEXT SIZE**.)

- 1 Press **Code**, then **Setup** **Z**.
- 2 Press **←** or **→** until **AUTO REDUCTION** is displayed.
- 3 Press **Home** **↑** or **End** **↓** until the desired setting is displayed, and then press **New Block** **←**.

If **TEXT SIZE** is selected and more text is added, the character size is reduced so the text fits within the specified label length.

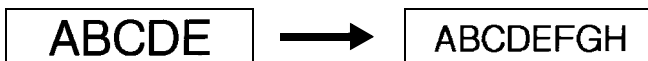

If **TEXT WIDTH** is selected and more text is added, the character width is reduced so the text fits within the specified label length.

However, after the character width is reduced to **MINIMUM**, the character size will be reduced so the text fits within the specified label length.

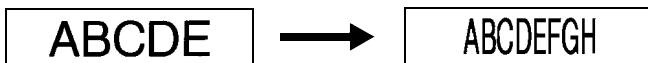







Calibrating the label length

If the length of the printed label does not correspond to the length specified with the Length function, the printed label length can be recalibrated with the Length Adjust function by selecting a setting between **-1** and **+3**. (The default setting is **0**.)

- 1 Press **Code**, then **Setup** **Z**.
- 2 Press **←** or **→** until **LENGTH ADJUST** is displayed.
- 3 Press **Home** **↑** or **End** **↓** until the desired setting is displayed, and then press **New Block** **←**.







Specifying if the PERSONAL symbol category is continually updated

You can specify whether symbols continue to be added to the **PERSONAL** symbol category (with the older symbols deleted) when the category becomes full (**ON**) or symbols are no longer added after the **PERSONAL** symbol category becomes full (**OFF**). (The default setting is **ON**.)

- 1 Press , then .
- 2 Press  or  until **SYMBOL SAVE** is displayed.
- 3 Press  or  until the desired setting is displayed, and then press .







Changing the units of measure

The units used for displaying measurements can be set to millimeters (**mm**) or inches (**inch**). (The default setting is **inch**.)

- 1 Press , then .
- 2 Press  or  until **UNITS** is displayed.
- 3 Press  or  until the desired setting is displayed, and then press .







Changing the language

The language of the menus, settings and messages can be changed by selecting **ENGLISH** or **FRANÇAIS**. (The default setting is **ENGLISH**.)

- 1 Press , then .
- 2 Press  or  until **LANGUAGE** is displayed.
- 3 Press  or  until the desired setting is displayed, and then press .

Displaying version information

This function can be used to display the version information for the P-touch software and built-in symbol set.





- 1 Press , then .
- 2 Press  or  until **VERSION INFO** is displayed.
- 3 Press  or  until the desired version information is displayed.
- 4 Press  to exit Setup mode.

5 Appendix

Troubleshooting



Problem	Solution
1 The display stays blank after you have turned on the machine.	<ul style="list-style-type: none">• Check that the AC adapter (model AD-60/AD-24) is connected correctly.• If you are using batteries, check that they are correctly inserted.• If the batteries are low, replace them with new ones.
2 The machine does not print or the printed characters are blurred.	<ul style="list-style-type: none">• Check that the back cover has been properly attached.• If the tape cassette is empty, replace it with a new one.
3 The text files that you stored in the memory are no longer there.	<ul style="list-style-type: none">• If the batteries are low, replace them with new ones.
4 The printed characters are not formed properly.	<ul style="list-style-type: none">• If you are using batteries, they may have a low charge. Try using the AC adapter or replace the batteries with new ones.
5 A blank horizontal line appears through the printed label.	<ul style="list-style-type: none">• Clean the print head as explained on <i>Cleaning the print head, rollers and tape cutter</i> on page 7.
6 Striped tape appears.	<ul style="list-style-type: none">• You have reached the end of the tape. Replace the tape cassette with a new one.
7 The P-touch has “locked up” (i.e., nothing happens when a key is pressed).	<ul style="list-style-type: none">• Turn off the P-touch, and then while holding down Code and R, turn the machine back on. The machine will restore, but the text and formats shown in the display and all text files stored in the memory are erased.

Error Message List

Error Message	Cause	Solution
1 BLOCK LIMIT!	<ul style="list-style-type: none"> This message appears if you try to use the Numbering function when multiple blocks of text have been entered with the PANEL Label Type mode selected. 	<ul style="list-style-type: none"> Cancel the Numbering function. Limit the number of text blocks to 1.
7 LINE LIMIT!	<ul style="list-style-type: none"> This message appears if 7 lines have already been entered in a text block when you press . 	<ul style="list-style-type: none"> Limit the number of lines in a text block to 7.
	<ul style="list-style-type: none"> This message appears if you delete , causing the number of lines in a block to exceed the 7-line limit. 	<ul style="list-style-type: none"> Adjust the number of lines so that the block will not have more than 7 lines.
50 LINE LIMIT REACHED!	<ul style="list-style-type: none"> This message appears if 50 text blocks have already been entered when you press , then . 	<ul style="list-style-type: none"> Limit the number of text blocks to 50.
BUFFER EMPTY!	<ul style="list-style-type: none"> This message appears if no text has been typed in when you try to print or Preview function. 	<ul style="list-style-type: none"> Type in some text before trying to perform any of these operations.
BUFFER FULL!	<ul style="list-style-type: none"> This message appears if you try to add a character, a space, a new line, a new block, a symbol, an accented character or a bar code after the maximum number of characters has already been entered. 	<ul style="list-style-type: none"> Delete some existing text before trying to add any more.
CASSETTE CHANGED!	<ul style="list-style-type: none"> This message appears if the tape cassette was changed while the P-touch paused for the tape to be cut. 	<ul style="list-style-type: none"> Change the tape cassette back again.
CHECK BATTERIES!	<ul style="list-style-type: none"> This message appears if a combination of new and used batteries, a combination of batteries of different types (alkaline, Ni-Cd and Ni-MH), manufacturers or models, or a combination of recharged and uncharged batteries have been installed. 	<ul style="list-style-type: none"> Replace the batteries with six new AA batteries of the same type. If rechargeable batteries are installed, recharge all batteries.

Error Message	Cause	Solution
CHECK SETTING IN LABEL TYPE MODE!	<ul style="list-style-type: none"> This message appears if you try to change the settings for the Length function or Frame function after a Label Type mode with a preset label length or frame has already been selected. 	<ul style="list-style-type: none"> Select a different Label Type mode.
<p>On 3/4" (18 mm) tape: CHECK THE NUMBER OF LINES! 5 MAX</p> <p>On 1/2" (12 mm) tape: CHECK THE NUMBER OF LINES! 3 MAX</p> <p>On 3/3" (9 mm) and 1/4" (6 mm) tape: CHECK THE NUMBER OF LINES! 2 MAX</p>	<ul style="list-style-type: none"> This message appears if you try to print or use the Preview function when the number of lines in the text is greater than the maximum possible for the installed tape. 	<ul style="list-style-type: none"> Reduce the number of lines or install a wider tape.
CHOOSE COPIES LESS THAN 1000!	<ul style="list-style-type: none"> This message appears if more than 1000 copies were selected with the Print Option functions. Note the number of copies plus the number of sequential labels cannot exceed 1000. 	<ul style="list-style-type: none"> Select less than 1000 copies.
CUTTER ERROR!	<ul style="list-style-type: none"> This message appears if the tape cutter button was pressed in when Print was pressed or the tape was being fed. 	<ul style="list-style-type: none"> Release the tape cutter button. If Print was pressed, press Feed to feed out any printed tape. If the problem cannot be corrected, contact your service representative.
INPUT WHOLE CODE!	<ul style="list-style-type: none"> This message appears if the required number of digits is not entered in the bar code data. 	<ul style="list-style-type: none"> Input the correct number of digits or change the bar code protocol.

Error Message	Cause	Solution
INPUT ABCD AT BEGIN & END!	<ul style="list-style-type: none"> This message appears if a letter between A and D has not been entered at the beginning and end of the bar code data when the CODABAR protocol is selected. 	<ul style="list-style-type: none"> Enter a letter between A and D at the beginning and end of the bar code data.
INSERT 1" TAPE	<ul style="list-style-type: none"> This message appears if a 1" (24-mm)-wide tape cassette is not installed when printing an Auto Format template created for 1" (24-mm)-wide tape. 	<ul style="list-style-type: none"> Install a 1" (24-mm)-wide tape cassette.
INSERT 24mm TAPE		
INSERT 3/4" TAPE	<ul style="list-style-type: none"> This message appears if a 3/4" (18-mm)-wide tape cassette is not installed when printing an Auto Format template created for 3/4" (18-mm)-wide tape. 	<ul style="list-style-type: none"> Install a 3/4" (18-mm)-wide tape cassette.
INSERT 18mm TAPE		
INSERT 1/2" TAPE	<ul style="list-style-type: none"> This message appears if a 1/2" (12-mm)-wide tape cassette is not installed when printing an Auto Format template created for 1/2" (12-mm)-wide tape. 	<ul style="list-style-type: none"> Install a 1/2" (12-mm)-wide tape cassette.
INSERT 12mm TAPE		
INSERT 3/8" TAPE	<ul style="list-style-type: none"> This message appears if a 3/8" (9-mm)-wide tape cassette is not installed when printing an Auto Format template created for 3/8" (9-mm)-wide tape. 	<ul style="list-style-type: none"> Install a 3/8" (9-mm)-wide tape cassette.
INSERT 9mm TAPE		
INSERT 1/4" TAPE	<ul style="list-style-type: none"> This message appears if a 1/4" (6-mm)-wide tape cassette is not installed when printing an Auto Format template created for 1/4" (6-mm)-wide tape. 	<ul style="list-style-type: none"> Install a 1/4" (6-mm)-wide tape cassette.
INSERT 6mm TAPE		
LENGTH LIMIT!	<ul style="list-style-type: none"> This message appears if you try to print or use the Preview function when the length of the text is greater than the 3' 1/3" (1 m) limit. 	<ul style="list-style-type: none"> Delete some of the text.
MEMORY FULL!	<ul style="list-style-type: none"> This message appears if you try to store a text file after approximately 2000 characters have already been stored in the memory. 	<ul style="list-style-type: none"> Delete an unwanted file to make space for the new one.

Error Message	Cause	Solution
MIN 4 DIGITS!	<ul style="list-style-type: none"> This message appears if less than the minimum four digits are entered as the bar code data. 	<ul style="list-style-type: none"> Enter a minimum of four digits before pressing . .
NO FILES!	<ul style="list-style-type: none"> This message appears if no files are stored in the memory when you try to recall or delete one. 	<ul style="list-style-type: none"> Store a text file before trying to recall or delete one.
NO TAPE!	<ul style="list-style-type: none"> This message appears if no tape cassette is installed when you try to feed the tape, print or use the Preview function. 	<ul style="list-style-type: none"> Install a tape cassette and try again.
TEXT TOO HIGH! XX BLOCK	<ul style="list-style-type: none"> This message appears if the size of the text is larger than the width of the installed tape. 	<ul style="list-style-type: none"> Reduce the size of the characters, install a tape with a greater width, or select the AUTO text size setting.
TEXT TOO LONG!	<ul style="list-style-type: none"> This message appears if the length of the text is longer than the label length that has been set with the Length function. 	<ul style="list-style-type: none"> Press , and then select a longer label length. Reduce the size or width of the characters, or select the AUTO text size setting.
TEXT TOO LONG! XX BLOCK	<ul style="list-style-type: none"> This message appears if you try to print a label that is longer than the specified block length. 	<ul style="list-style-type: none"> Select a longer block length.
VALUE OUT OF RANGE!	<ul style="list-style-type: none"> This message appears if the value entered while setting the Margin, Length, and Block Length function is not within the allowable range. This message appears if the values for the blocks to be printed is not within the allowable range. 	<ul style="list-style-type: none"> Type in a value that is within the allowable range.

Machine Specifications

Hardware

Power supply:	Six AA alkaline batteries or Six AA rechargeable batteries or AC adapter (model AD-60/AD-24)
Input device:	Keyboard (56 keys)
LCD:	48 × 132 dots + Caps and other indicators
Print tape:	TZ tape is available in the following five widths: 1/4" (6 mm) 3/8" (9 mm) 1/2" (12 mm) 3/4" (18 mm) 1" (24 mm)
Print head:	18.1 mm (height)/180 dpi (resolution)
Tape cutter:	Manual cutter
Dimensions:	With tape cutter button: 5 3/16" (W) × 9 1/4" (D) × 3 3/8" (H) (131 mm (W) × 235 mm (D) × 86 mm (H)) Without tape cutter button: 4 1/2" (W) × 9 1/4" (D) × 3 3/8" (H) (114 mm (W) × 235 mm (D) × 86 mm (H))
Weight:	1.23 lb. (560 g)

Software

Character fonts:	1 built-in font (Helsinki)
Character sizes:	AUTO plus 7 point sizes (1, 2, 3, 4, 6, 9 and 12 mm (6, 9, 12, 18, 24, 36 and 48 points))
Character styles:	Normal, Bold, Outline, Italic, Italic + Bold, and Italic + Outline
Buffer size:	Maximum 512 characters Maximum 7 lines Maximum 50 blocks
Memory size:	Approximately 2000 characters

Index

- A**
- AC adapter 8
 - Accent function 17
 - alignment 28
 - arrow keys 2, 14, 15
 - Auto Format function 29
 - Auto Format keys 2
 - Auto Reduction function 38
- B**
- backspace key 2, 14, 17
 - bar code
 - special characters 19
 - Bar Code function 18
 - batteries 4
 - block number 2
 - block range 33
 - bold text style 27
 - indicator 2
- C**
- cancelling 14
 - Caps indicator 2
 - Caps mode 15
 - center text alignment 28
 - indicator 2
 - chain printing 37
 - character
 - size 25
 - style 27
 - width 26
 - choosing 14
 - default setting 14
 - cleaning
 - print head 7
 - rollers 7
 - tape cutter 7
 - Clear function 17
- Code indicator 2
- confirming 14
 - Contrast function 37
 - copies 31
 - cursor 15
 - Cut function 37
 - cut-pause 37
- D**
- default setting 14
 - deleting
 - memory files 36
 - text 17
 - display 2
 - contrast 37
- E**
- error messages 41
 - Extra Strength Adhesive Tape 6
- F**
- Feed key 2, 30
 - Flag mode 11
 - Flexible ID Tape 6
 - Format key 25, 26, 27
 - formatting 25, 26, 27
 - Frame function 24
 - frame indicator 2
- G**
- global format key 2
 - global formatting
 - character size 25
 - character style 27
 - character width 26

I	
indicators	2
block number	2
bold text style	2
Caps	2
center text alignment	2
Code	2
frame	2
Insert	2
italic text style	2
justified text alignment	2
Label Type setting.....	2
left text alignment.....	2
length	2
low battery	2
outline text style	2
right text alignment.....	2
Shift.....	2
size.....	2
width.....	2
Insert indicator	2
Insert key.....	16
italic text style	27
indicator	2
J	
justified text alignment	28
indicator	2
K	
keyboard	2
L	
label margins.....	23
Label Type key	2
Label Type mode.....	9
Label Type setting indicator.....	2
language	39
LCD display	2
left text alignment.....	28
indicator	2
length adjustment.....	38
Length function	23
length indicator	2
local formatting	
character size	25
character style	27
character width	26
locked up	40
low battery indicator	2
lowercase letters.....	15
M	
Margin function.....	23
measurements	39
Memory key	35
mirror printing.....	33
N	
New Block function	16
Normal mode.....	9
Numbering function	31
numbers	15
O	
outline text style	27
indicator.....	2
P	
Panel mode	12
PERSONAL symbol category	22
setup	39
Port Block mode.....	12
Port mode	12
power key	2, 8
preview	30
print head.....	7
Print key.....	2, 30
printing	
text block range.....	33
problems	40

R	
recalling	36
Repeat Printing function	31
return key	2, 14, 16
right text alignment	28
indicator	2
rollers	7
Rotate & Repeat mode	10
Rotate mode	10

S	
selecting	14, 15
default setting	14
Setup key	37
Shift indicator	2
Shift mode	15
size	25
indicator	2
Space key	14, 15
storing	35
style	27
Symbol key	20

T	
tape	
cassettes	4
cutter	7
templates	
Auto Format	29
text	
alignment	28
size	25
size adjustment	38
style	27
width	26
width adjustment	38
troubleshooting	40

U	
units	39
uppercase letters	15

V	
version	39
Vertical mode	9

W	
width	26
indicator	2

Contact Information (For USA Only)

Service Center Locations

If you need a local service center, please call 1-800-284-HELP (4357) to locate the authorized service center closest to you.

Note: Be sure to call the Service Center before your visit.

Service centers do not provide operational assistance. See "Operational Assistance".

Operational Assistance

For technical and operational assistance you may call Brother Customer Service at: Voice 1-877-4-PTouch, or Fax 1-901-379-1210

Assistance on the Internet

For product information and downloading the latest drivers: <http://www.brother.com>
For purchasing accessories and certain Brother products: <http://www.brothermall.com>

Accessories and Supplies

To order Brother accessories or supplies by Visa, MasterCard, Discover or American Express, you may call toll free 1-888-879-3232, or complete the order form in your user's guide and fax both sides of the form to 1-800-947-1445.

For purchasing accessories on the Internet: <http://www.brothermall.com>

To order by mail or pay by check, please complete the accessory order form and mail it along with payment to:

Brother International Corporation
Attn: Consumer Accessory Division
P.O. Box 341332
Bartlett, TN 38133-1332

Fax-Back System

Brother Customer Service has installed an easy-to-use Fax-Back System so you can get instant answers to common technical questions and product information for all Brother products.

This system is available 24 hours a day, 7 days a week. You can use the system to send the information to any fax machine, not just the one you are calling from.

Please call 1-800-521-2846 and follow the voice prompts to receive faxed instructions on how to use the system and an index of Fax-Back subjects.

GUÍA DE USUARIO

Introducción

Gracias por adquirir esta P-touch.

Con ella podrá elegir entre una serie de estilos de caracteres, tamaños y marcos para diseñar prácticas etiquetas personalizadas que responden a cualquier necesidad. Además, seleccionando tipos de etiquetas preformateadas podrá etiquetar, con rapidez y facilidad, paneles de conexiones, cables, conectores y otros componentes.

Con esta P-touch puede imprimir etiquetas legibles y duraderas en un instante. Su calidad y rendimiento hacen de ella un aparato muy práctico para usar en planta o en la calle.

Aunque es muy sencilla, le sugerimos que antes de empezar a usarla lea esta Guía del usuario con detenimiento, y que la tenga siempre a mano para futuras consultas.

Declaración de cumplimiento con la Comisión Federal de Comunicaciones (FCC) (sólo para EE.UU.)

Parte responsable : Brother International Corporation
100 Somerset Corporate Boulevard
Bridgewater, NJ 08807-0911 EE.UU.
TEL : (908) 704-1700

declara que el producto
Nombre del producto : Impresora de etiquetas P-touch de Brother
Número de modelo : PT-1400

cumple la Parte 15 de las Normas FCC. El funcionamiento está sujeto a las dos condiciones siguientes: (1) este dispositivo no puede causar interferencias perjudiciales y (2) este dispositivo debe aceptar cualquier interferencia que reciba, incluso interferencias que puedan dar lugar a un funcionamiento no deseado.

Este equipo ha sido probado y se ha determinado que cumple los límites correspondientes a un dispositivo digital de Clase B, conforme a la Parte 15 de las Normas FCC. Dichos límites están diseñados para ofrecer una protección razonable contra interferencias perjudiciales en una instalación residencial. Este equipo genera, usa y puede radiar energía de radiofrecuencia; si no se instala y se usa de acuerdo con las instrucciones, puede causar interferencias perjudiciales a las comunicaciones por radio. Sin embargo, no existe ninguna garantía de que no puedan producirse interferencias en una determinada instalación. En el caso de que este equipo cause interferencias perjudiciales a la recepción de emisiones de radio o televisión, cosa que puede determinar apagando y encendiendo el equipo, el usuario puede intentar corregir dichas interferencias recurriendo a una o más de las medidas siguientes:

- Reorientar o reubicar la antena receptora.
- Aumentar la separación entre el equipo y el receptor.
- Conectar el equipo a una toma de corriente que se encuentre en un circuito distinto de aquél al que está conectado el receptor.
- Consultar al distribuidor o a un técnico de radiotelevisión con experiencia.
- Debe usarse el cable de interfaz incluido a fin de asegurarse de que se cumplen los límites correspondientes a un dispositivo digital de Clase B.
- Cualquier cambio o modificación que no cuente con la aprobación expresa de Brother Industries, Ltd. podría anular la autorización del usuario para manejar el equipo.

ÍNDICE

1. Para empezar	1
Descripción general	1
<i>Vista superior y vista inferior</i>	<i>1</i>
<i>Teclado y visualizador de LCD</i>	<i>2</i>
Precauciones generales	3
Pilas y casetes de cinta	4
<i>Instalación de las pilas y el casete de cinta</i>	<i>4</i>
Limpieza	7
<i>Limpieza del cabezal de impresión, rodillos y cortador de la cinta</i>	<i>7</i>
Adaptador de CA opcional	8
<i>Conexión del adaptador de CA</i>	<i>8</i>
Conexión/desconexión de la P-touch	8
2. Modos de tipo de etiqueta	9
Selección de un modo de tipo de etiqueta	9
Modos Normal y Vertical	9
Modos Girar (ROTATE) y Girar y repetir (ROT-REP)	10
Modo Bandera (FLAG)	11
Modos Puerto (PORT) y Panel (PANEL)	12
3. Funciones básicas	14
Cómo realizar las operaciones básicas	14
<i>Elección de funciones, parámetros, ajustes y grupos</i>	<i>14</i>
<i>Elección del ajuste predeterminado</i>	<i>14</i>
<i>Confirmación de una elección</i>	<i>14</i>
<i>Cancelación de una elección</i>	<i>14</i>
Introducción de los datos de la etiqueta	15
<i>Introducción y modificación de texto</i>	<i>15</i>
<i>Introducción de un carácter acentuado</i>	<i>17</i>
<i>Introducción de un código de barras</i>	<i>18</i>
<i>Introducción de un símbolo</i>	<i>20</i>

Cómo formatear la etiqueta	23
<i>Definición de la longitud de la etiqueta</i>	23
<i>Definición de un tamaño de margen</i>	23
<i>Cómo enmarcar el texto</i>	24
<i>Definición del tamaño de los caracteres</i>	25
<i>Definición de la anchura de los caracteres</i>	26
<i>Definición del estilo de los caracteres</i>	27
<i>Uso de las plantillas de formato automático</i>	29
Impresión de etiquetas	30
<i>Vista preliminar de la maquetación de la etiqueta</i>	30
<i>Avance de la cinta</i>	30
<i>Impresión de una etiqueta</i>	30
<i>Uso de funciones de impresión especiales</i>	31
Almacenamiento e invocación de archivos	35
<i>Almacenamiento de texto de etiquetas</i>	35
<i>Invocación de texto previamente almacenado</i>	36
<i>Borrado de texto almacenado</i>	36

4. Ajustes de la máquina**37**

<i>Selección de la forma de avance y corte de la cinta</i>	37
<i>Ajuste del contraste del visualizador</i>	37
<i>Ajuste de la función de reducción automática</i>	38
<i>Calibración de la longitud de la etiqueta</i>	38
<i>Definición de la actualización continua de la categoría de símbolos</i>	
<i>PERSONAL</i>	39
<i>Cambio de las unidades de medida</i>	39
<i>Cambio del idioma</i>	39
<i>Visualización de información sobre la versión</i>	39

5. Apéndice**40**

Solución de problemas	40
Lista de mensajes de error	41
Características técnicas de la máquina	45
<i>Hardware</i>	45
<i>Software</i>	45
Índice alfabético	46
Información de contacto (sólo para EE.UU.)	49

1 Para empezar

Descripción general

Vista superior y vista inferior

Vista

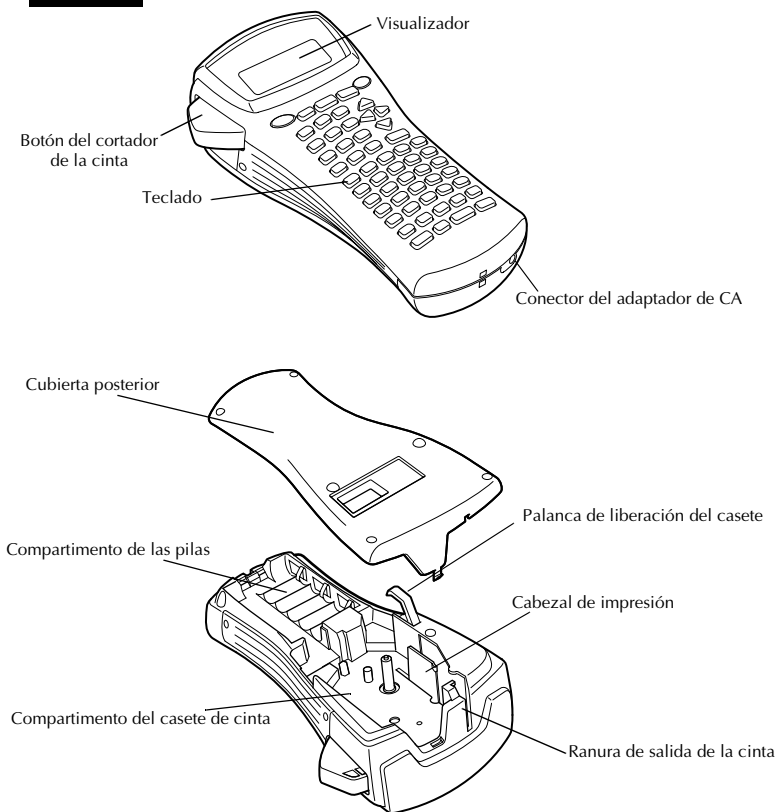

Vista inferior

Teclado y visualizador de LCD

PT-1400

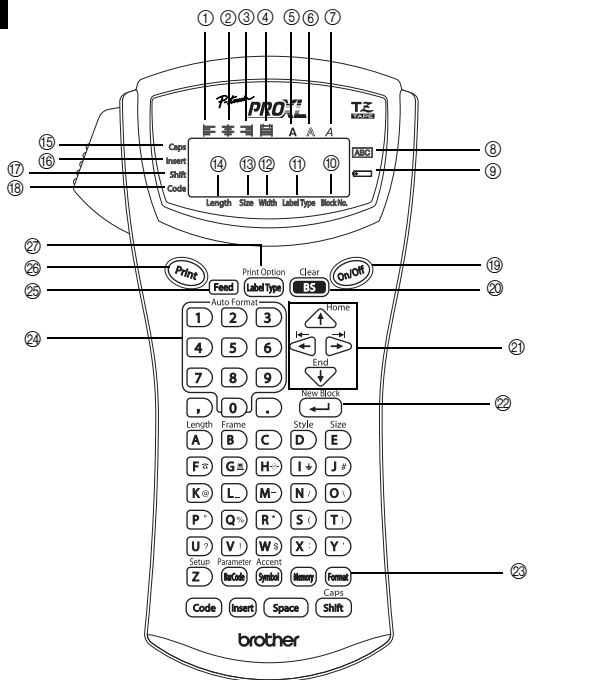

- ① Alineación del texto a la izquierda (página 28)
- ② Alineación del texto centrada (página 28)
- ③ Alineación del texto a la derecha (página 28)
- ④ Alineación del texto justificada (página 28)
- ⑤ Estilo de texto negrilla (página 27)
- ⑥ Estilo de texto perfilado (página 27)
- ⑦ Estilo de texto cursiva (página 27)
- ⑧ Marco (página 24)
- ⑨ Pilas gastadas (página 5)
- ⑩ Número de bloque (página 16)
- ⑪ Ajuste de tipo de etiqueta (página 9)
- ⑫ Ajuste de anchura (página 26)
- ⑬ Ajuste de tamaño (páginas 25 y 26)
- ⑭ Ajuste de longitud (página 23)
- ⑮ Modo de mayúsculas continuas (página 15)
- ⑯ Modo de inserción (página 16)
- ⑰ Modo de mayúscula individual (página 15)
- ⑱ Modo de código (página 15)
- ⑲ Tecla de alimentación (página 8)
- ⑳ Tecla de retroceso (páginas 14 y 17)
- ㉑ Teclas de flechas (página 14)
- ㉒ Tecla de retorno (páginas 14 y 16)
- ㉓ Tecla de formato global (página 25)
- ㉔ Teclas de formato automático (página 29)
- ㉕ Tecla de avance (página 30)
- ㉖ Tecla de impresión (página 30)
- ㉗ Tipo de etiqueta (página 9)

Precauciones generales

- **Emplee sólo cintas TZ Brother con esta máquina. No emplee cintas que no tengan la marca .**
- No tire de la cinta que avanza desde la P-touch. Podría dañar el casete.
- No utilice la máquina en lugares muy polvorientos. Manténgala alejada de la luz solar directa y de la lluvia.
- No exponga la máquina a temperaturas o humedad muy altas. No la deje nunca sobre el tablero de instrumentos ni en la parte trasera del automóvil.
- No guarde los casetes de cinta en lugares expuestos a la luz solar directa, a una humedad elevada o al polvo.
- No deje nada que sea de goma o vinilo encima de la máquina durante períodos prolongados. Podría producir manchas.
- No limpie la máquina con alcohol ni con otros disolventes orgánicos. Emplee solamente un paño suave y seco.
- No ponga ningún objeto extraño dentro de la máquina, ni ningún objeto pesado encima.
- Para evitar daños, no toque el borde de la cuchilla.
- Emplee sólo el adaptador de CA diseñado exclusivamente para esta máquina. El empleo de otro cancelaría la garantía.
- No intente desmontar el adaptador de CA.
- Cuando la máquina no se vaya a utilizar durante períodos prolongados, desenchufe el adaptador de CA y saque las pilas para evitar fugas que puedan dañar la máquina.
- Emplee seis pilas alcalinas o recargables (Ni-Cd o Ni-MH) de tamaño AA.
- Nunca intente desmontar la P-touch.

Pilas y casetes de cinta

Esta máquina ha sido diseñada para permitirle cambiar las pilas y los casetes de cinta con rapidez y facilidad. Con pilas instaladas, esta máquina compacta y portátil puede utilizarse en cualquier lugar. Existen para esta máquina una amplia gama de casetes de cinta TZ de distintos tipos, colores y tamaños, que permiten crear etiquetas diferentes codificadas por colores o tamaños.

Instalación de las pilas y el casete de cinta

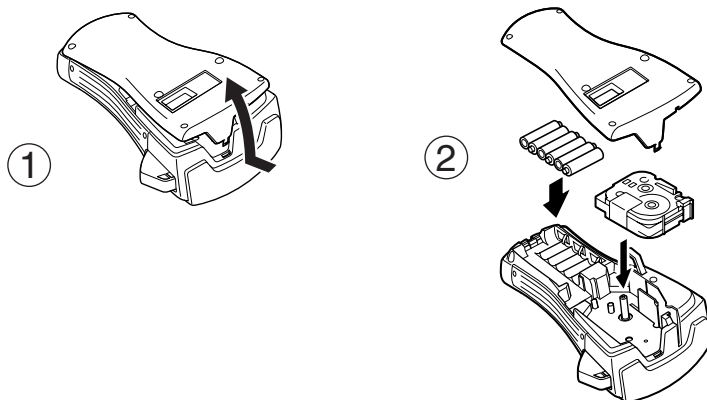

Observaciones acerca de las pilas

- Esta P-touch requiere seis pilas de tamaño AA. Pueden usarse pilas recargables (Ni-Cd o Ni-MH) en lugar de 6 pilas alcalinas.
- Las pilas recargables no se pueden cargar dejándolas en la P-touch con el adaptador de CA conectado. Cárguelas con un cargador diseñado específicamente para el tipo de pilas utilizado. Para más detalles acerca de las pilas recargables, consulte las instrucciones suministradas con ellas.
- A fin de evitar fugas o daños a la máquina, absténgase de utilizar estos tipos de pilas:
 - Pilas de manganeso
 - Una combinación de pilas nuevas y usadas
 - Una combinación de pilas de diferentes tipos (alcalinas, Ni-Cd y Ni-MH), de diferentes fabricantes o de diferentes modelos
 - Una combinación de pilas recargadas y sin recargar

- ☞ Asegúrese de insertar las pilas de forma que sus polos queden orientados en la dirección correcta. Con las pilas instaladas, la P-touch determina cuánta carga queda durante la impresión y el avance de la cinta. Si detecta que queda poca, se encenderá el indicador de pilas gastadas (☐). Cuando esto suceda, cambie las pilas. En determinadas condiciones de funcionamiento, es posible que el indicador de pilas gastadas no se encienda.
- ☞ Antes de cambiar las pilas, compruebe que la unidad P-touch está apagada. Además, al cambiar las pilas, inserte las nuevas antes de que transcurran cinco minutos de haber extraído las viejas; de lo contrario, el texto visualizado en la pantalla y cualquier texto almacenado en la memoria se perderán.
- ☞ Si prevé que no va a utilizar la P-touch durante un período prolongado, extraiga las pilas. Cuando se desconecta la máquina, se pierden el texto que se muestra en la pantalla y el que está almacenado en la memoria.
- ☞ Dado que las pilas que se incluyen empiezan a descargarse desde el mismo momento en que la unidad sale de fábrica, es posible que su duración no cumpla las especificaciones, dependiendo de cuándo se empiece a usar la unidad.

Observaciones acerca de los casetes de cinta

- ☞ Antes de instalar el casete de cinta, cerciórese de que el extremo de la cinta avanza por debajo de las guías. Si el casete de cinta que va a instalar tiene una cinta entintadora y que está floja, haga girar la rueda dentada con el dedo, en el sentido de la flecha del casete, hasta tensarla.

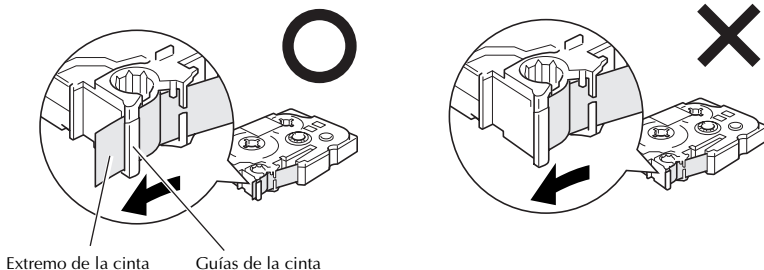

- ☞ Cuando inserte el casete de cinta, asegúrese de que la cinta interior no se enganche en el ángulo de la guía metálica.
- ☞ Después de instalar un casete de cinta, pulse **Feed** una vez para tensarla y, a continuación, pulse el botón del cortador para cortar la que sobre.
- ☞ Corte siempre la cinta antes de sacarla de la máquina. Si tira de la cinta antes de cortarla, puede dañar el casete.

Cinta con fuerza adhesiva extra

- ❏ Para superficies con textura, rugosas o resbaladizas, se recomienda usar cinta con fuerza adhesiva extra.
- ❏ Aunque en la hoja de instrucciones que acompaña al casete de cinta con fuerza adhesiva extra se recomienda cortarla con tijeras, el cortador de esta P-touch es capaz de cortar este tipo de cinta.

Cinta de identificación flexible

- ❏ Para aquellas aplicaciones que requieran etiquetas más flexibles (por ejemplo, para pegarlas sobre curvas pronunciadas o en torno a objetos cilíndricos), se recomienda usar cinta de identificación flexible.
- ❏ Las etiquetas creadas con cinta de identificación flexible no están diseñadas para servir como aislante eléctrico.
- ❏ Cuando pegue etiquetas en torno a objetos cilíndricos, el diámetro del objeto debe ser, como mínimo, de 1/8" (3 mm); si es menor, pegue la etiqueta en forma de bandera y utilice el modo de tipo de etiqueta **FLAG**. Además, los extremos solapados de la etiqueta o la bandera deben tener un mínimo de 3/16" (5 mm).
- ❏ Si se curva el objeto cilíndrico después de pegar la etiqueta, es posible que esta se despegue.

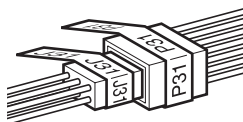
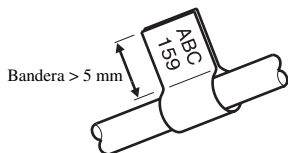
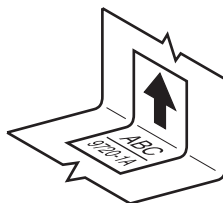
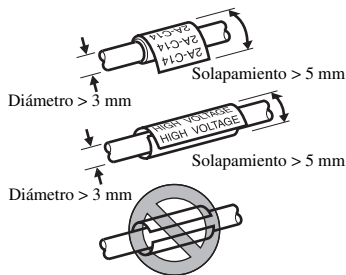

Limpieza

Es posible que, de vez en cuando, haya que limpiar ciertas partes de la P-touch. Puede que se adhiera polvo o suciedad al cabezal de impresión y a los rodillos de la P-touch, especialmente si se emplea la unidad en exteriores o en lugares con mucho polvo. Con el uso, el cortador puede recubrirse de adhesivo, haciendo difícil cortar la cinta.

Limpieza del cabezal de impresión, rodillos y cortador de la cinta

- ⚠ Antes de limpiar el cabezal de impresión y los rodillos, pulse **(On/Off)** para desconectar la P-touch y, a continuación, extraiga las pilas y desenchufe el adaptador de CA opcional.
- ⚠ Tenga mucho cuidado de no tocar las cuchillas del cortador con los dedos.

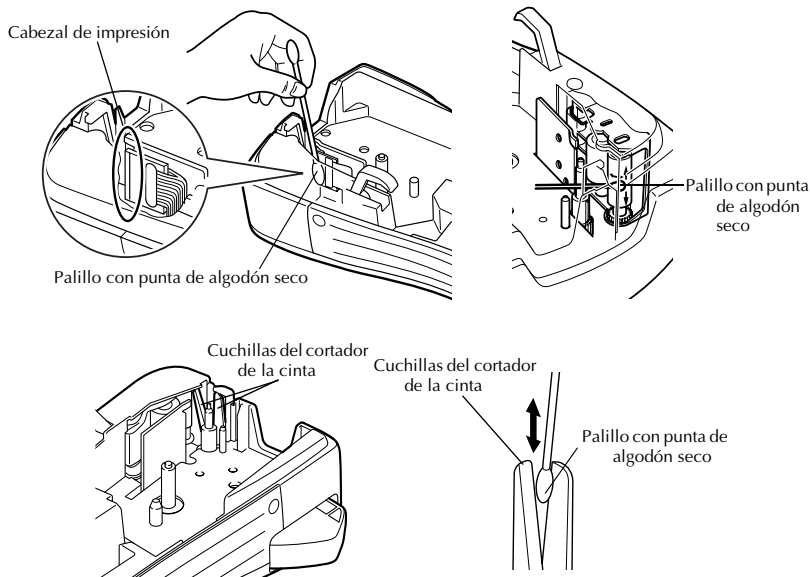

Observaciones acerca de la limpieza del cabezal de impresión y de los rodillos

- ⚠ Si aparece una franja horizontal en blanco en el texto de la etiqueta, limpie el cabezal de impresión de la máquina.
- ⚠ Será más fácil limpiar el cabezal de impresión si se emplea el casete de limpieza opcional (TZ-CL4).

Observaciones acerca de la limpieza del cortador de la cinta

- ☞ Si observa que la cinta no se corta bien, limpie las cuchillas del cortador.

Adaptador de CA opcional

Cuando vaya a imprimir muchas etiquetas, o bien etiquetas que contengan gran cantidad de texto, puede ser conveniente conectar la P-touch a una toma eléctrica normal mediante el adaptador de CA opcional.

Conexión del adaptador de CA

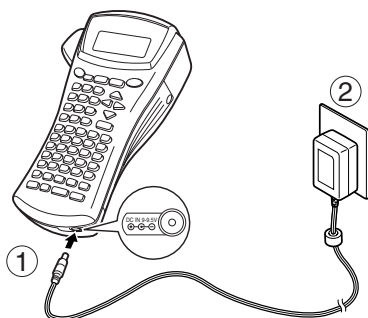

Observaciones acerca del adaptador de CA

- ☞ Emplee sólo el adaptador de CA diseñado exclusivamente para esta máquina.
- ☞ Si prevé que no va a utilizar la P-touch durante un período prolongado, desconecte el adaptador de CA. Cuando se desconecta la máquina, se pierden el texto que se muestra en la pantalla y el que está almacenado en la memoria.

Conexión/desconexión de la P-touch

Pulse **(ON/OFF)** para encender o apagar la P-touch.

Si la P-touch tiene pilas instaladas o ha estado enchufada mediante el adaptador de CA, cuando se vuelva a encender se visualizará el texto de la sesión anterior. Esta característica le permite interrumpir la creación de una etiqueta, desconectar la máquina y posteriormente reanudar el trabajo en la misma etiqueta sin tener que volver a introducir el texto.

Tanto si la P-touch está funcionando a pilas como si está conectada al adaptador de CA, se apagará automáticamente cuando transcurran 5 minutos sin que se pulse ninguna tecla ni se realice ninguna operación.

2 Modos de tipo de etiqueta

Selección de un modo de tipo de etiqueta

Presionando ^{Print Option}(Label Type), podrá seleccionar uno de los dos modos normales de diseño e impresión de etiquetas personalizadas, o cualquiera de los cinco modos especiales disponibles para imprimir etiquetas preformateadas para la identificación de paneles de conexiones, cables, conectores y otros componentes.

- 1 Pulse ^{Print Option}(Label Type).
- 2 Pulse ^{Home}(↑) o ^{End}(↓) (o siga pulsando ^{Print Option}(Label Type)) hasta que se visualice el modo deseado. (Para obtener más información sobre cada modo de tipo de etiqueta, consulte las secciones siguientes.)
- 3 Pulse ^{New Block}(←) para aplicar el modo de tipo de etiqueta seleccionado.
 - Si ha seleccionado **NORMAL** o **VERTICAL**, siga escribiendo el texto de la etiqueta como se describe en capítulo 3, *Funciones básicas*.
 - Si ha seleccionado **ROTATE**, **ROT-REP**, **PORT**, **PANEL** o **FLAG**, siga estos pasos.
- 4 Pulse ^{Left}(←) o ^{Right}(→) hasta que se visualice el parámetro deseado.
- 5 Pulse ^{Home}(↑) o ^{End}(↓) hasta que se visualice el ajuste deseado (o utilice las teclas numéricas para escribirlo).
- 6 Pulse ^{New Block}(←) para aplicar los ajustes seleccionados.
- 7 Escriba el texto de cada etiqueta en un bloque de texto diferente.
- 8 Imprima las etiquetas.
 - Para imprimir una sola copia de cada etiqueta, presione ^{Print}(Print).
 - Para imprimir múltiples copias o varias copias con ciertos caracteres que se incrementan, o bien para imprimir usando cualquier otra función de impresión especial, presione ^{Code}(Code) y luego ^{Print Option}(Label Type) y elija sus opciones. (Para obtener más información, consulte *Uso de funciones de impresión especiales* en la página 31.)

Modos Normal y Vertical

Con los modos **Normal** y **Vertical** se pueden formatear e imprimir etiquetas para todas las necesidades.

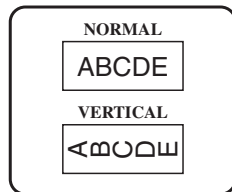

Después de seleccionar el modo de tipo de etiqueta **NORMAL** o **VERTICAL**, el texto de la etiqueta puede escribirse, formatearse, imprimirse y cortarse de la manera habitual. Con el modo de tipo de etiqueta **Normal**, el texto introducido se imprime horizontalmente a lo largo de la etiqueta. Con el modo de tipo de etiqueta **Vertical**, el texto introducido se imprime verticalmente a lo largo de la etiqueta.

Modos Girar (ROTATE) y Girar y repetir (ROT-REP)

Las etiquetas impresas usando estos modos de tipo de etiqueta se pueden enrollar en torno a hilos y cables para identificarlos. Con estos dos modelos el texto gira 90° hacia la izquierda y cada bloque de texto se imprime en una etiqueta diferente, como se muestra a continuación. Con el modo Girar y repetir, el texto se imprime repetidamente a lo largo de la etiqueta, a fin de que se pueda leer fácilmente desde cualquier ángulo.

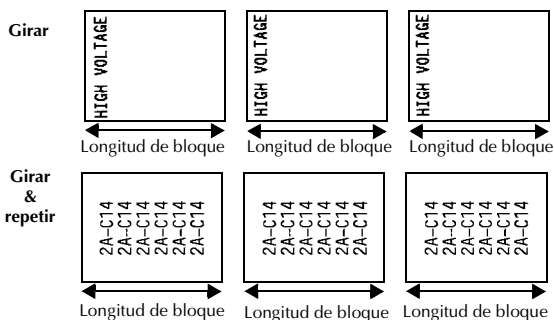
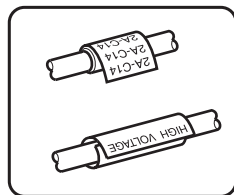

Después de seleccionar el modo de tipo de etiqueta **ROTATE** o **ROT-REP**, defina la longitud de cada etiqueta y, si lo desea, un estilo de marco.

- **BLK LEN.** (longitud del bloque): 0,80" a 8,00" (20 a 200 mm)
Valor predeterminado: 1,20" (30 mm)
- **FRAME** (marco): **OFF**, 1, 2, 3, 4
Valor predeterminado: **OFF**

- ☞ Un bloque puede contener 7 líneas de texto como máximo y, con el modo de tipo de etiqueta **ROT-REP**, sólo se imprimirán las líneas de texto que quepan en la etiqueta.
- ☞ Para aquellas etiquetas que vayan a pegarse a hilos o cables, se recomienda usar cinta de identificación flexible. Cuando enrolle cinta de identificación flexible en torno a objetos cilíndricos, el diámetro del objeto debe ser, como mínimo, de 1/8" (3 mm); si es menor, utilice el modo de tipo de etiqueta **FLAG** (bandera). Además, los extremos solapados de la etiqueta o la longitud de la bandera deben tener un mínimo de 3/16" (5 mm).

Modo Bandera (FLAG)

Las etiquetas impresas usando este modo de tipo de etiqueta se pueden enrollar en torno a hilos o cables pegando los extremos entre sí para formar una bandera. Con el modo **FLAG**, cada bloque de texto se imprime en ambos extremos de etiquetas diferentes. La longitud de la parte no impresa de esta etiqueta es igual a la circunferencia del hilo o cable. Además, el texto se puede imprimir horizontalmente o con un giro de 90°.

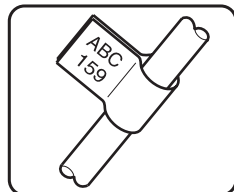

ROTATE
ajustado
a OFF

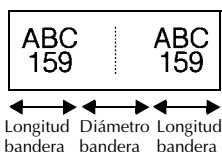

ROTATE
ajustado
a ON

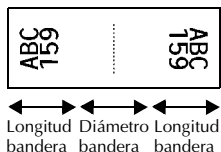

Después de seleccionar el modo de tipo de etiqueta **FLAG**, defina la longitud y el diámetro de la bandera, un estilo de marco si lo desea, y si el texto debe girarse o no.

- **FLAG ϕ** (diámetro de la bandera): 0,00" a 4,00" (0 a 100 mm)
Valor predeterminado: 0,25" (7 mm)
- **FLAG LEN** (longitud de la bandera): 0,40" a 8,00" (10 a 200 mm)
Valor predeterminado: 1,20" (30 mm)
- **FRAME** (marco): **OFF**, 1, 2, 3, 4
Valor predeterminado: **OFF**
- **ROTATE** (girar): **OFF**, **ON**
Valor predeterminado: **OFF**

☞ Un bloque puede contener 7 líneas de texto como máximo.

☞ Para aquellas etiquetas que vayan a pegarse a hilos o cables, se recomienda usar cinta de identificación flexible. Para enrollar cinta de identificación flexible en torno a objetos cilíndricos, utilice el modo de tipo de etiqueta **FLAG** (bandera) si el diámetro del objeto es inferior a 1/8" (3 mm). Además, la longitud de la bandera debe tener un mínimo de 3/16" (5 mm).

Modos Puerto (PORT) y Panel (PANEL)

Las etiquetas impresas usando estos modos de tipo de etiqueta se pueden usar para identificar diversos componentes o paneles.

Con el modo de tipo de etiqueta **Port**, cada bloque de texto se imprime en una etiqueta diferente, por lo que dichas etiquetas son útiles para identificar distintos componentes o puertos que no estén espaciados de forma regular.

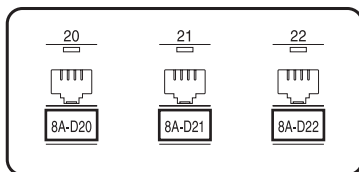

Con el modo de tipo de etiqueta **Panel**, todos los bloques de texto se imprimen en una misma etiqueta a intervalos regulares, por lo que resulta útil para una hilera de conmutadores, fusibles o conectores de un panel de conexiones con idéntica distancia de separación. Además, los bloques de texto se pueden imprimir en el orden en que se han escrito o en el orden inverso.

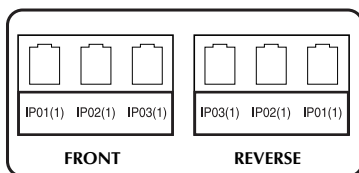

Port

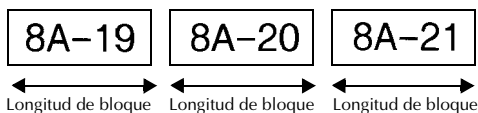

Panel
(PRINT ajustado a FRONT)

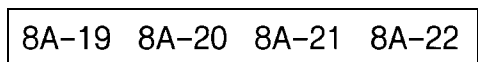

Panel
(PRINT ajustado a REVERSE)







Después de seleccionar el modo de tipo de etiqueta **PORT** o **PANEL**, defina la longitud de cada bloque de texto o etiqueta y, si lo desea, seleccione un estilo de marco. Con el modo de tipo de etiqueta **PANEL**, seleccione si los bloques de texto deben imprimirse en el orden en que se han escrito o en el orden inverso.

3 Funciones básicas

Cómo realizar las operaciones básicas

Elección de funciones, parámetros, ajustes y grupos

- Si aparece “◀▶”, pulse  para seleccionar el elemento anterior o  para seleccionar el elemento siguiente.
- Si aparece “◀▶”, pulse  para seleccionar el elemento anterior o  para seleccionar el elemento siguiente.

Elección del ajuste predeterminado

- Para seleccionar el ajuste predeterminado de una función o parámetro, pulse .

Confirmación de una elección

- Para seleccionar un elemento de una lista, para aplicar un ajuste seleccionado o para responder “sí”, pulse .



Cancelación de una elección





- Para abandonar una función y volver a la pantalla anterior sin cambiar el texto o para responder “no”, pulse .

Introducción de los datos de la etiqueta

Introducción y modificación de texto

Introducción de caracteres

- Para escribir una letra minúscula, un número, una coma o un punto, sólo tiene que pulsar la tecla correspondiente.
- Para escribir una letra mayúscula, pulse  para entrar en el modo de mayúscula individual y seguidamente pulse la letra correspondiente.
- Para escribir letras mayúsculas de forma continua, pulse  y seguidamente  para entrar en el modo de mayúsculas continuas, y proceda a escribir.













- ☞ Para salir del modo de mayúscula individual sin escribir ninguna letra, pulse .
- ☞ Para salir del modo de mayúsculas continuas, pulse  y luego .
- ☞ Para escribir una letra minúscula en el modo de mayúsculas continuas, pulse  y luego la letra correspondiente.



Introducción de espacios

- Para añadir un espacio en blanco al texto, pulse .

Cómo mover el cursor

Puede mover el cursor para revisar y modificar el texto o para seleccionar las diversas funciones y ajustes.

- Para mover el cursor hacia la izquierda, hacia la derecha, hacia arriba o hacia abajo, pulse , ,  o .
- Para mover el cursor al principio de la línea de texto actual, pulse  y luego .
- Para mover el cursor al final de la línea de texto actual, pulse  y luego .
- Para mover el cursor al principio del texto introducido, pulse  y luego .
- Para mover el cursor al final del texto introducido, pulse  y luego .

- ☞ Para mover el cursor varios caracteres o líneas de una vez, mantenga presionada ,  o .

Cómo añadir una nueva línea de texto



- Para poner fin a la línea de texto actual y empezar otra nueva, pulse . Aparecerá “↵” al final de la línea.

El número de líneas de texto que se pueden imprimir depende de la anchura de la cinta.

Anchura de la cinta	Número máximo de líneas que pueden imprimirse
1/4" (6 mm)	2
3/8" (9 mm)	2
1/2" (12 mm)	3
3/4" (18 mm)	5
1" (24 mm)	7

El número de línea que aparece en el visualizador indica el número de línea del bloque de texto.

Cómo añadir un nuevo bloque de texto

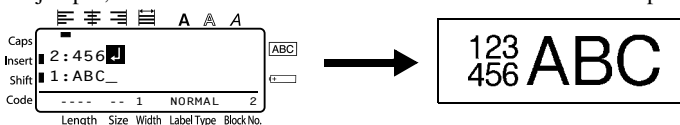

- Para crear un nuevo bloque de texto de forma que una sección del texto pueda tener un número de líneas distinto de otra, pulse  y seguidamente . Aparecerá “↵” al final del bloque.

Por ejemplo, un texto escrito tal como se indica a continuación se imprimirá así.









- El número de bloques de texto que se pueden imprimir depende de la anchura de la cinta.
- Una etiqueta puede contener cincuenta bloques de texto como máximo.
- El número del bloque en el que se encuentra el cursor aparece indicado en la parte inferior del visualizador.
- Todos los bloques de texto tienen las mismas características de formato.
- Cuando intente imprimir una gran cantidad de datos a la vez, es posible que algunas etiquetas salgan en blanco. Por ejemplo, al imprimir 50 registros, el número máximo de caracteres que se pueden imprimir de una vez está limitado aproximadamente a 200.

Inserción de texto

- Para insertar el texto que escriba en la posición actual del cursor, cerciórese de que está visualizado el indicador **Insert**. Si no está visualizado, pulse  para entrar en el modo de **inserción**.
- Para reemplazar el texto de la posición actual del cursor en lugar de insertarlo, pulse  para salir del modo de **inserción**.

Borrado de texto





- Para eliminar caracteres situados a la izquierda de la posición actual del cursor, pulse  hasta que haya borrado todos los caracteres deseados.
- Para borrar todo el texto:
 - 1 Pulse  y luego .
 - 2 Pulse  o  para seleccionar **TEXT ONLY** (para borrar sólo el texto) o **TEXT&FORMAT** (para borrar todo el texto y devolver todas las funciones de formato a sus valores predeterminados).
 - 3 Pulse .





Introducción de un carácter acentuado

Se pueden usar varios caracteres acentuados con la función de acentos.

Están disponibles los siguientes caracteres acentuados:

Letra	Caracteres acentuados						Letra	Caracteres acentuados					
	0	1	2	3	4	5		0	1	2	3	4	5
A	À	Á	Ä	Â	Ã	Æ	a	à	á	ä	â	ã	æ
C	Ç						c	ç					
E	È	É	Ë	Ê	Ë		e	è	é	ë	ê	ë	
I	Í	Ï	Î				i	í	ï	î			
N	Ñ						n	ñ					
O	Ó	Ö	Ô	Õ			o	ó	ö	ô	õ		
U	Ù	Ú	Û	Û			u	ù	ú	ü	û		

- 1 Pulse  y luego . Aparecerá el mensaje “ACCENT a-u/A-U?”.
- 2 Presione la tecla correspondiente a la letra del carácter acentuado deseado hasta seleccionar el carácter deseado.
- 3 Añada los caracteres acentuados al texto.
 - Para añadir un solo carácter acentuado o el último de una serie, vaya al paso **5**.
 - Para añadir al texto una serie de caracteres acentuados, pulse  y luego .
- 4 Para cada carácter acentuado adicional, repita los pasos **2** y **3**.
- 5 Pulse .

- ☞ Para escribir un carácter acentuado en mayúsculas, pulse  (o ) y  para entrar en el modo de mayúsculas continuas) antes de pulsar la tecla de la letra.
- ☞ También se puede seleccionar un carácter acentuado escribiendo el código correspondiente que puede ver en la tabla anterior. Por ejemplo, para añadir “Ä” al texto, escriba “A2” y luego pulse .

Introducción de un código de barras

Esta función permite imprimir códigos de barras como parte de las etiquetas.







- ☞ Como esta máquina no ha sido específicamente diseñada para hacer etiquetas de códigos de barras, es posible que algunos lectores de códigos de barras no puedan leer las etiquetas.
- ☞ Es posible que los lectores de códigos de barras no puedan leer códigos de barras impresos con ciertos colores de tinta sobre ciertos colores de cinta de etiquetas. Para obtener unos resultados óptimos, imprima las etiquetas de códigos de barras en cinta de caracteres negros sobre fondo blanco.

Además, hay distintos parámetros que le permiten crear códigos de barras más personalizados.



Parámetro	Ajustes
PROTOCOL (protocolo)	CODE 39, I-2/5, EAN13, EAN8, UPC-A, UPC-E, CODABAR, EAN128, CODE128
WIDTH (anchura de barra)	MEDIUM, SMALL, LARGE
UNDER# (números impresos debajo del código de barras)	ON, OFF
CHECK DIGIT (dígito de comprobación)	OFF, ON









- ☞ El parámetro **CHECK DIGIT** sólo está disponible con los protocolos **CODE 39, I-2/5** y **CODABAR**.

Configuración de los parámetros de código de barras

- 1 Pulse  y luego .
- 2 Pulse  o  hasta que se visualice el parámetro que desee cambiar.
- 3 Pulse  o  hasta que se visualice el ajuste deseado.
- 4 Repita los pasos 2 y 3 hasta ajustar todos los parámetros de la forma deseada.
- 5 Pulse .

Introducción de los datos del código de barras

- 1 Pulse .
- 2 Escriba los datos del nuevo código de barras o modifique los datos existentes.
- 3 Pulse  para añadir el código de barras al texto.

-  Para añadir caracteres especiales a los datos del código de barras (sólo con los protocolos **CODE39**, **CODABAR**, **EAN128** o **CODE128**), coloque el cursor debajo del carácter situado inmediatamente a la derecha del punto en el que desea añadir el carácter especial, y seguidamente pulse . Pulse  o  hasta que se visualice el carácter especial deseado y seguidamente pulse  para añadir el carácter a los datos. (En las tablas siguientes puede ver una lista de los caracteres especiales disponibles.)
-  Para cambiar los datos o los ajustes de los parámetros **WIDTH** o **UNDER#** de un código de barras ya añadido al texto, pulse  y luego .

Los siguientes caracteres especiales solamente pueden añadirse a códigos de barras creados con el protocolo **CODE39** o **CODABAR**.

CODE39

CODABAR

Símbolo	Carácter	Símbolo	Carácter
0	-	4	/
1	.	5	+
2	(SPACE)	6	%
3	\$		







Símbolo	Carácter	Símbolo	Carácter
0	-	3	/
1	\$	4	.
2	:	5	+

Los siguientes caracteres especiales solamente podrán añadirse a códigos de barras creados con los protocolos **EAN128** y **CODE128**.



Símbolo	Carácter	Símbolo	Carácter	Símbolo	Carácter	Símbolo	Carácter
0	(SPACE)	18	<	36	BEL	54	EM
1	!	19	=	37	BS	55	SUB
2	”	20	>	38	HT	56	ESC
3	#	21	?	39	LF	57	{
4	\$	22	@	40	VT	58	FS
5	%	23	[41	FF	59	
6	&	24	\	42	CR	60	GS
7	'	25]	43	SO	61	}
8	(26	^	44	SI	62	RS
9)	27	_	45	DLE	63	~
10	*	28	NUL	46	DC1	64	US
11	+	29	`	47	DC2	65	DEL
12	,	30	SOH	48	DC3	66	FNC3
13	-	31	STX	49	DC4	67	FNC2
14	.	32	ETX	50	NAK	68	FNC4
15	/	33	EOT	51	SYN	69	FNC1
16	:	34	ENQ	52	ETB		
17	;	35	ACK	53	CAN		

Introducción de un símbolo



La función de símbolo permite utilizar 147 símbolos e imágenes.





























































- 1 Pulse . Se visualizará la última categoría utilizada.
- 2 Pulse  o  para seleccionar la categoría deseada.
- 3 Pulse  o  hasta seleccionar el símbolo deseado.
- 4 Añada el símbolo o símbolos al texto.
 - Para añadir un solo símbolo o el último de una serie, vaya al paso 6.
 - Para añadir al texto una serie de símbolos, pulse  y luego .
- 5 Para cada símbolo adicional, repita los pasos 2 a 4.

6 Pulse .

- También se puede seleccionar un símbolo escribiendo el código correspondiente, que puede ver en la tabla siguiente. Por ejemplo, para añadir “?” al texto, escriba “A02” y luego pulse .
- Algunos símbolos aparecen impresos en color sobre el teclado. Para usar un símbolo impreso sobre una tecla, pulse  para entrar en el modo de código y seguidamente pulse la tecla correspondiente.

Están disponibles los siguientes símbolos:

Categoría	Símbolos									
A PUNTUACIÓN	.	,	?	!	“	'	:	;	—	—
	00	01	02	03	04	05	06	07	08	09
	\	/	&	¿	¡	~	§	•		
	10	11	12	13	14	15	16	17		
B COMERCIALES	@	#	%	®	©	™				
	00	01	02	03	04	05				
C MATEMÁTICOS	+	-	×	*	±	=	÷			
	00	01	02	03	04	05	06			
D PARÉNTESIS	()	[]	<	>	«	»		
	00	01	02	03	04	05	06	07		
E FLECHAS	→	←	↑	↓	➔	➔	⬆	⬇		
	00	01	02	03	04	05	06	07	08	09
F UNIDADES	°	\$	¥	£	€	¢	Fr	f	φ	
	00	01	02	03	04	05	06	07	08	
G CARACTERES INTERNACIONALES	ā	ā	ß	ß	ɑ	β	γ	δ	μ	Ω
	00	01	02	03	04	05	06	07	08	09
	Đ	đ	Ɔ	ɔ	ij					
	10	11	12	13	14					

Categoría	Símbolos									
H NUMÉRICOS	1/2	1/3	1/4	0	1	2	1	2		
	00	01	02	03	04	05	06	07		
I PICTOGRÁFICOS	★	○	●	□	△	◆				
	00	01	02	03	04	05				
J ELECTRICIDAD / ELECTRÓNICA										
	00	01	02	03	04	05	06	07	08	09
										
	10	11	12	13	14	15	16	17	18	19
										
	20	21	22	23	24	25	26	27	28	29
										
	30	31	32	33	34	35	36	37	38	39
										
	40	41	42							
K PROHIBICIÓN										
	00	01	02							
L ADVERTENCIA										
	00	01	02	03	04	05	06			
M COMUNICACIONES										
	00	01	02							
N OTROS										
	00	01	02	03						
Z CATEGORÍA PERSONAL	*En la categoría de símbolos PERSONAL se guardan automáticamente los símbolos seleccionados más recientemente, hasta un máximo de 16.									

Una vez que se llene la categoría de símbolos **PERSONAL**, los nuevos símbolos que se seleccionen se sobrescribirán sobre los antiguos a menos que la función de guardar símbolos esté ajustada a **OFF** (desactivada). (Consulte *Definición de la actualización continua de la categoría de símbolos PERSONAL* en la página 39.)

Cómo formatear la etiqueta

Definición de la longitud de la etiqueta

La longitud de la etiqueta se puede definir como sigue:

- 1 Pulse **Code** y luego **A**^{Length}.
- 2 Pulse **←** o **→** hasta que se visualice **LENGTH**.
- 3 Pulse **↑**^{Home} o **↓**^{End} hasta que se visualice la longitud de etiqueta deseada (o utilice las teclas numéricas para escribirla).
- 4 Pulse **←**^{New Block}.

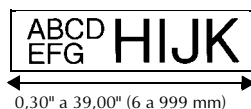





Definición de un tamaño de margen

Se puede definir el tamaño de los márgenes izquierdo y derecho del texto.















- 1 Pulse **Code** y luego **A**^{Length}.
- 2 Pulse **←** o **→** hasta que se visualice **MARGIN**.
- 3 Pulse **↑**^{Home} o **↓**^{End} hasta que se visualice el ajuste de márgenes deseado (o utilice las teclas numéricas para escribirlo).
- 4 Pulse **←**^{New Block}.



Cómo enmarcar el texto

- 1 Pulse  y luego .
- 2 Pulse  o  hasta que se visualice el ajuste de marco deseado.
- 3 Pulse . El ajuste seleccionado se aplicará a todo el texto.







Están disponibles los siguientes estilos de marco:

Ajuste de marco	Muestra	Ajuste de marco	Muestra
1		8	
2		9	
3		10	
4		11	
5		12	
6		13	
7		14	





Definición del tamaño de los caracteres

El tamaño de los caracteres se puede definir para todo el texto de la etiqueta o sólo para el texto de la línea en la que está el cursor.

Cómo formatear el tamaño de los caracteres de todo el texto

- 1 Pulse .
- 2 Presione  o  hasta que se visualice **GLB SIZE**.
- 3 Pulse  o  hasta que se visualice el ajuste de tamaño de caracteres deseado.
- 4 Pulse . El ajuste seleccionado se aplicará a todo el texto.

Cómo formatear el tamaño de los caracteres de una línea

- 1 Mueva el cursor a la línea de texto cuyo tamaño desea cambiar.
- 2 Pulse  y luego .
- 3 Pulse  o  hasta que se visualice el ajuste de tamaño de caracteres deseado.
- 4 Pulse . El ajuste seleccionado solamente se aplicará a la línea de texto en la que está situado el cursor.







☞ Puesto que los tamaños de texto que se pueden imprimir dependen de la anchura de la cinta, la tabla siguiente indica el tamaño máximo de texto que se puede utilizar con cada anchura de cinta.

Anchura de la cinta	Tamaño máximo del texto
1/4" (6 mm)	12 puntos (3 mm)
3/8" (9 mm)	18 puntos (4 mm)
1/2" (12 mm)	24 puntos (6 mm)
3/4" (18 mm)	36 puntos (9 mm)
1" (24 mm)	48 puntos (12 mm)







☞ Con el ajuste **AUTO** seleccionado y el texto de un bloque de una sola línea que sólo contenga letras mayúsculas (sin letras acentuadas), el texto se imprime ligeramente más grande que el máximo correspondiente a la anchura de la cinta.

Definición de la anchura de los caracteres

Cómo formatear la anchura de todo el texto

- 1 Pulse .
- 2 Presione  o  hasta que se visualice **GLB WIDE**.
- 3 Pulse  o  hasta que se visualice el ajuste de anchura de caracteres deseado.
- 4 Pulse . El ajuste seleccionado se aplicará a todo el texto.

Cómo formatear la anchura de una línea







- 1 Mueva el cursor a la línea de texto cuya anchura de caracteres desea cambiar.
- 2 Pulse  y luego .
- 3 Pulse  o  hasta que se visualice **WIDTH**.
- 4 Pulse  o  hasta que se visualice el ajuste de anchura de caracteres deseado.
- 5 Pulse . El ajuste seleccionado solamente se aplicará a la línea de texto en la que está situado el cursor.

Están disponibles las siguientes anchuras para cada tamaño de texto indicado:





Anchura Tamaño	NORMAL	NARROW (condensado)	MINIMUM (mínimo)	WIDE (ancho)
12 mm (48 puntos)	ABC	ABC	ABC	ABC
9 mm (36 puntos)	ABC	ABC	ABC	ABC
6 mm (24 puntos)	ABC	ABC	ABC	ABC
4 mm (18 puntos)	ABC	ABC	ABC	ABC
3 mm (12 puntos)	ABC	ABC	ABC	ABC
2 mm (9 puntos)	ABC	ABC	ABC	ABC
1 mm (6 puntos)	ABC	ABC	ABC	ABC

Definición del estilo de los caracteres

Cómo formatear el estilo de los caracteres de todo el texto

- 1 Pulse .
- 2 Presione  o  hasta que se visualice **GLB STYL**.
- 3 Pulse  o  hasta que se visualice el ajuste de estilo de caracteres deseado.
- 4 Pulse . El ajuste seleccionado se aplicará a todo el texto.







Cómo formatear el estilo de los caracteres de una línea

- 1 Mueva el cursor a la línea de texto cuyo estilo de caracteres desea cambiar.
- 2 Pulse  y luego .
- 3 Pulse  o  hasta que se visualice el ajuste de estilo de caracteres deseado.
- 4 Pulse . El ajuste seleccionado solamente se aplicará a la línea de texto en la que está situado el cursor.

Están disponibles los siguientes estilos de texto:

Ajuste de estilo	Muestra	Ajuste de estilo	Muestra
NORMAL	ABC	ITALIC (cursiva)	<i>ABC</i>
BOLD (negrilla)	ABC	I+BOLD (cursiva y negrilla)	<i>ABC</i>
OUTLINE (perfilado)	ABC	I+OUTL (cursiva y perfilado)	<i>ABC</i>

Definición de la alineación de todas las líneas de texto

- 1 Pulse .
- 2 Pulse  o  hasta que se visualice **ALIGN**.
- 3 Pulse  o  hasta que se visualice el ajuste deseado.
- 4 Pulse . El ajuste seleccionado se aplicará a todo el texto.

Están disponibles los siguientes ajustes de alineación:

ABC DEFGH IJKLM

LEFT (izquierda)

ABC DEFGH IJKLM

CENTER (centrada)

ABC DEFGH IJKLM

RIGHT (derecha)







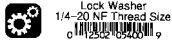

A B C DEFGH IJKLM

JUSTIFY (justificada)

Uso de las plantillas de formato automático

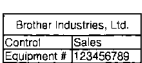
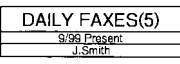



Están disponibles diversas plantillas de etiquetas preformateadas que permiten crear con rapidez y facilidad etiquetas para una gran variedad de aplicaciones, desde identificar el contenido de cajas y expedientes hasta etiquetar equipos y crear identificadores. Sólo tiene que seleccionar una de las diez plantillas de etiquetas, escribir texto en cada uno de sus campos y la etiqueta estará lista para imprimir.







Están disponibles las siguientes plantillas de etiquetas:

Tecla	Nombre de la plantilla	Anchura cinta × Longitud etiqueta	Campos de la plantilla	Muestra
①	BIN BOX	3/4" × 2.80" (18 mm × 70 mm)	① SYMBOL? ② TEXT1? ③ TEXT2? ④ BAR CODE?	
②	ASSET1	1" × 3.35" (24 mm × 84 mm)	① TEXT1? ② TEXT2? ③ BAR CODE?	
③	ASSET2	1" × 3.15" (24 mm × 80 mm)	① TEXT? ② BAR CODE?	
④	ASSET3	1" × 1.65" (24 mm × 41 mm)	① TEXT? ② BAR CODE?	
⑤	ASSET4	1" × 2.25" (24 mm × 56 mm)	① TEXT1? ② TEXT2? ③ TEXT3? ④ TEXT4? ⑤ TEXT5?	
⑥	ID LABEL	1" × 2.80" (24 mm × 70 mm)	① TEXT1? ② TEXT2? ③ TEXT3?	
⑦	SIGN	1" × 4.05" (24 mm × 102 mm)	① SYMBOL? ② TEXT1? ③ TEXT2?	
⑧	BADGE	3/4" × 4.05" (18 mm × 102 mm)	① NAME? ② COMPANY?	
⑨	FILING	1/2" × 3.55" (12 mm × 89 mm)	① TITLE? ② SUBTITLE?	
⑩	IC CHIP	3/8" × 1.05" (9 mm × 26 mm)	① TEXT1? ② TEXT2?	

① Pulse  y luego la tecla numérica asignada a la plantilla que desee usar.

② Pulse . Se visualizará el primer campo de la plantilla seleccionada.



- 3 Pulse  o  para visualizar cada uno de los campos y seguidamente escriba el texto.
- 4
- Para imprimir una sola copia, pulse .
 - Para imprimir múltiples copias, varias copias con ciertos caracteres que se incrementan o una imagen especular del texto, pulse  y luego . (Para obtener más información, consulte *Uso de funciones de impresión especiales* en la página 31.)



-  En los campos de la plantilla se pueden introducir caracteres acentuados (página 17), símbolos (página 20) y códigos de barras (página 18).
-  Para dejar de usar la plantilla, visualice el último campo y luego pulse . Aparecerá el menú de formato automático. Pulse  or  hasta que aparezca **EXIT** y seguidamente pulse .



Impresión de etiquetas

Vista preliminar de la maquetación de la etiqueta





La función de **vista preliminar** permite ver una muestra de la maquetación del texto.

- Para usar la vista preliminar, pulse  y luego . Se indicará la longitud de la cinta actual en el ángulo inferior izquierdo del visualizador.

-  Para desplazar la vista preliminar de impresión a la derecha o a la izquierda, pulse  o .

-  Para volver al texto, pulse  o .

Avance de la cinta

- Para hacer avanzar 1" (23 mm) de cinta, pulse . Aparecerá el mensaje "FEED".
-  Pulse  para hacer avanzar el excedente de cinta impresa después de pulsar  para abandonar la impresión.

Impresión de una etiqueta

- Para imprimir una etiqueta, pulse . Aparecerá el mensaje "WORKING" y luego "COPIES", seguido del número de la etiqueta que se esté imprimiendo.

Uso de funciones de impresión especiales

Están disponibles diversas funciones de impresión especial que permiten imprimir múltiples copias de las etiquetas, imprimir varias copias incrementando los valores de ciertos caracteres, imprimir secciones concretas de texto de etiqueta o imprimir texto de etiqueta en forma de imagen especular.

Impresión de múltiples copias de una etiqueta

La función de copias múltiples permite imprimir hasta 99 copias del mismo texto.

- 1 Pulse **Code** y luego **Print Option (Label Type)**.
- 2 Pulse **←** o **→** hasta que se visualice **COPIES**.
- 3 Pulse **Home (↑)** o **End (↓)** hasta que se visualice el número de copias deseado (o utilice las teclas numéricas para escribirlo).
- 4 Pulse **New Block (←)** (o **Print**). Aparecerá **START** en el menú de opciones de impresión.
- 5 Presione **New Block (←)** (o **Print**) para empezar a imprimir el número de copias definido. El número de cada copia se visualizará mientras esta se esté imprimiendo.

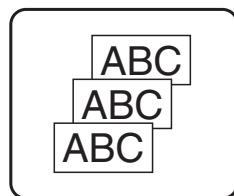









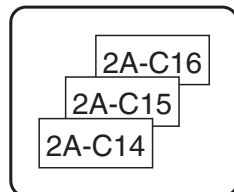









- ☞ Si la función de corte está ajustada a **1** o **3**, aparecerá el mensaje “CUT TAPE TO CONTINUE” (corte la cinta para continuar) después de que se imprima cada etiqueta. Pulse el botón del cortador de la cinta para cortar la etiqueta y proseguir con la impresión.
- ☞ Corte la cinta antes de que transcurran 5 minutos desde la aparición del mensaje.
- ☞ Si desea ver las distintas opciones disponibles para cortar la cinta, consulte *Selección de la forma de avance y corte de la cinta* en la página 37.
- ☞ Para definir ajustes para otras funciones de opción de impresión en lugar de continuar con el paso **5**, presione **Home (↑)** o **End (↓)** hasta que se visualice **CONTINUE** en el menú de opciones de impresión y seguidamente presione **New Block (←)**.

Impresión de múltiples copias con caracteres en incremento

La función de numeración puede utilizarse para imprimir varias copias del mismo texto incrementando los valores de ciertos caracteres (letras, números o datos de código de barras) después de la impresión de cada etiqueta. Este tipo de incremento automático es muy útil para imprimir etiquetas de números de serie, etiquetas de control de producción u otras etiquetas que requieran códigos ascendentes.

- 1 Pulse **Code** y luego **Print Option (Label Type)**.



- 2 Pulse  o  hasta que se visualice **NUMBER**.
- 3 Pulse  o  hasta que se visualice el número de copias deseado (o utilice las teclas numéricas para escribirlo).
- 4 Pulse . Aparecerá el mensaje “START?”. (Para definir únicamente el carácter en el que se encuentra el cursor como campo de numeración, pulse  y vaya al paso 9.)
- 5 Pulse , ,  o  hasta que parpadee el primer carácter que desee incluir en el campo de numeración.
- 6 Pulse . Aparecerá el mensaje “END?”.
- 7 Pulse , ,  o  hasta que parpadee el último carácter que desee incluir en el campo de numeración.
- 8 Pulse . Aparecerá **START** en el menú de opciones de impresión.
- 9 Presione  (o ) para empezar a imprimir el número de etiquetas definido. El número de cada copia se visualizará mientras esta se esté imprimiendo.

- ☞ Si la función de corte está ajustada a **1** o **3**, aparecerá el mensaje “CUT TAPE TO CONTINUE” (corte la cinta para continuar) después de que se imprima cada etiqueta. Pulse el botón del cortador de la cinta para cortar la etiqueta y proseguir con la impresión.
- ☞ Corte la cinta antes de que transcurran 5 minutos desde la aparición del mensaje.
- ☞ Si desea ver las distintas opciones disponibles para cortar la cinta, consulte *Selección de la forma de avance y corte de la cinta* en la página 37.

☞ Las letras y los números se incrementarán como se muestra a continuación:

0 → 1 → ...9 → 0 → ...
 A → B → ...Z → A → ...
 a → b → ...z → a → ...
 A0 → A1 → ...A9 → B0 → ...

Los espacios (representados por el signo de subrayado “_” en los ejemplos siguientes) podrán utilizarse para ajustar el espacio entre caracteres o para controlar el número de dígitos a imprimir.

_Z → AA → ...ZZ → AA → ...
 _9 → 10 → ...99 → 00 → ...
 1_9 → 2_0 → ...9_9 → 0_0 → ...

- ☞ Solamente se puede seleccionar un campo de numeración de cualquier texto.
- ☞ Un campo de numeración debe estar contenido íntegramente en una línea de texto de un solo bloque.
- ☞ Se pueden seleccionar cinco caracteres como máximo para el campo de numeración.
- ☞ Si incluye en el campo de numeración un carácter no alfanumérico, como un símbolo, solamente se incrementarán las letras y los números de dicho campo cuando imprima las etiquetas; si el campo sólo contiene un carácter no alfanumérico, solamente se imprimirá una etiqueta.

- ☞ Para definir ajustes para otras funciones de opción de impresión en lugar de continuar con el paso 9, presione o hasta que se visualice **CONTINUE** en el menú de opciones de impresión y seguidamente presione .
- ☞ Se pueden hacer incrementos a un bloque de texto. Si se selecciona un código de barras como campo de incremento (numeración) en el paso 5, ningún otro bloque de texto podrá ser incrementado.

Impresión de una serie de bloques de texto

La función de impresión por bloques permite seleccionar la serie de bloques de texto a imprimir.

- 1 Pulse y luego .
- 2 Pulse o hasta que parpadee el primer número de la serie visualizada debajo de **BLOCK NO.**
- 3 Pulse o hasta que se visualice el número de bloque deseado (o utilice las teclas numéricas para escribirlo).
- 4 Pulse para que parpadee el segundo número de la serie visualizada debajo de **BLOCK NO.**
- 5 Pulse o hasta que se visualice el número de bloque deseado (o utilice las teclas numéricas para escribirlo).
- 6 Pulse (o). Aparecerá **START** en el menú de opciones de impresión.
- 7 Presione (o) para empezar a imprimir el número de etiquetas definido. El número de cada copia se visualizará mientras esta se esté imprimiendo.

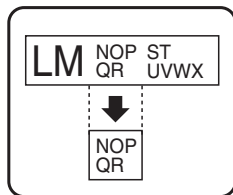







- ☞ Para definir ajustes para otras funciones de opción de impresión en lugar de continuar con el paso 7, presione o hasta que se visualice **CONTINUE** en el menú de opciones de impresión y seguidamente presione .

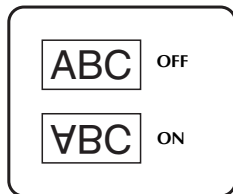

Impresión especular de etiquetas

Con esta función, podrá imprimir la etiqueta de modo que el texto pueda leerse desde el lado del adhesivo de la cinta. Si se adhieren etiquetas con impresión especular a un cristal u otro material transparente, podrán leerse correctamente desde el lado opuesto.

- 1 Pulse y luego .
- 2 Pulse o hasta que se visualice **MIRROR**.



- 3 Pulse  o  hasta que se visualice **ON**.
- 4 Pulse  (o ). Aparecerá **START** en el menú de opciones de impresión.
- 5 Presione  (o ) para empezar a imprimir el número de etiquetas definido. El número de cada copia se visualizará mientras esta se esté imprimiendo.

- ☞ Cuando emplee la función de impresión en modo espejo, el texto se imprimirá en cinta transparente.
- ☞ Para definir ajustes para otras funciones de opción de impresión en lugar de continuar con el paso 5, presione  o  hasta que se visualice **CONTINUE** en el menú de opciones de impresión y seguidamente presione .

Combinación de funciones de impresión especiales

Muchas de las funciones de impresión especiales se pueden combinar, en función de diversas condiciones, por ejemplo, en función del modo de tipo de etiqueta seleccionado o de si se está usando una plantilla. Por ejemplo, si se combinan las operaciones de la función de copias múltiples y la función de numeración para imprimir dos copias de una etiqueta después de seleccionar “1” como campo de numeración y tres incrementos, se imprimirán las etiquetas que se muestran arriba.

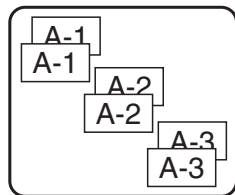









- ☞ Para obtener más información sobre las diversas funciones de impresión especiales, consulte la sección anterior que corresponda.

Almacenamiento e invocación de archivos

Si hay textos de etiquetas que usa con frecuencia, puede guardarlos en memoria, junto con su formato, y después invocarlos fácilmente para poder modificarlos e imprimirlos con rapidez. Cuando se almacena un archivo de texto, se le asigna un número para poder invocarlo más fácilmente. En la memoria se pueden almacenar hasta 10 archivos de texto o unos 2000 caracteres. Al usar la función de invocación, se obtiene una copia del archivo de texto almacenado, por lo que el texto se puede modificar o imprimir sin cambiar el archivo almacenado originalmente. Cuando ya no necesite un archivo o cuando necesite más espacio, podrá utilizar la función de borrado para eliminarlo.

Almacenamiento de texto de etiquetas

- 1 Pulse .
- 2 Pulse  o  hasta que se visualice **STORE**.
- 3 Pulse .
- 4 Pulse  o  hasta que se visualice el número de archivo en el que desee almacenar el texto.
- 5 Pulse .

- ☞ Si ya se ha almacenado el número máximo de caracteres, aparecerá el mensaje “MEMORY FULL!” en el visualizador. Cuando ocurra esto, deberá borrar un archivo de texto existente para poder almacenar el nuevo.
- ☞ Si ya se ha almacenado un archivo bajo el número seleccionado, aparecerá el mensaje “OVERWRITE?” en el visualizador. Para reemplazar el archivo almacenado por el nuevo, pulse . Para retroceder y elegir otro número de archivo sin reemplazar el archivo de texto, pulse  y después seleccione un número de archivo diferente.

Invocación de texto previamente almacenado

- 1 Pulse **Memory**.
- 2 Pulse **Home** o **End** hasta que se visualice **RECALL**.
- 3 Pulse **New Block**.
- 4 Pulse **Home** o **End** hasta que se visualice el número de archivo que contiene el texto que desea invocar.
- 5 Pulse **New Block**. Cualquier texto previamente introducido en el visualizador se borrará y aparecerá en el visualizador el texto almacenado en el número de archivo seleccionado.

Para ver otras partes del archivo de texto seleccionado, pulse **Left Arrow** o **Right Arrow**.

Borrado de texto almacenado

- 1 Pulse **Memory**.
- 2 Pulse **Home** o **End** hasta que se visualice **CLEAR**.
- 3 Pulse **New Block**.
- 4 Pulse **Home** o **End** hasta que se visualice el número de archivo que contiene el texto que desea borrar.
- 5 Seleccione el archivo o archivos que desee borrar.
 - Para borrar un solo archivo, vaya al paso **6**.
 - Para seleccionar varios archivos, presione **Space**. El número del archivo actual aparecerá resaltado. Para seguir seleccionando archivos de texto, repita el paso **4** y luego pulse **Space** hasta que haya seleccionado todos los archivos que desee borrar.
 - Para borrar todos los archivos, presione **Code** y luego **Space**.
- 6 Pulse **New Block**. Aparecerá el mensaje “OK TO CLEAR?” (o “CLEAR ALL?” si se han seleccionado todos los archivos).
- 7 Pulse **New Block**. Se borrará el texto almacenado en los archivos seleccionados.

Para ver otras partes del archivo de texto seleccionado, pulse **Left Arrow** o **Right Arrow**.

Para quitar un archivo de texto de la lista de archivos a borrar, visualícelo y pulse **Space** para que el número del archivo deje de estar resaltado.

4 Ajustes de la máquina

Existen diversas funciones que permiten cambiar y ajustar el funcionamiento de la P-touch.

Selección de la forma de avance y corte de la cinta

La función **Cut** permite definir la forma de avance de la cinta una vez impresa. Los ajustes de la función de corte son combinaciones de dos métodos diferentes:

pausa-corte (la máquina detiene la impresión para que se pueda cortar la cinta) e impresión en cadena (la última copia no avanza para ser cortada, con lo que se reduce la cantidad de cinta desperdiciada).

La impresión en cadena es una función de ahorro diseñada para ayudar a eliminar el "desperdicio de cinta" al comienzo de las etiquetas. Sin la impresión en cadena, el excedente de la anterior sesión de impresión se corta antes de que se imprima la primera etiqueta de la sesión actual. En cambio, si se selecciona un ajuste que incluya la impresión en cadena, la última etiqueta de la sesión anterior se quedará en la máquina (no avanzará), a fin de que la etiqueta siguiente pueda imprimirse sin desperdiciar cinta. Cuando se imprima la última etiqueta, pulse **Feed** para que avance la cadena de etiquetas y seguidamente pulse el botón del cortador de la cinta para cortarla.

Están disponibles los siguientes ajustes: (El ajuste predeterminado es 1.)

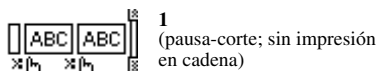

1 (pausa-corte; sin impresión en cadena)

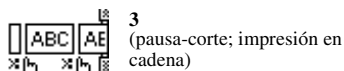

3 (pausa-corte; impresión en cadena)

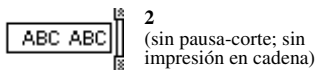

2 (sin pausa-corte; sin impresión en cadena)

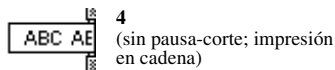

4 (sin pausa-corte; impresión en cadena)

- 1 Pulse **Code** y luego **Setup** (Z).
- 2 Pulse **←** o **→** hasta que se visualice CUT.
- 3 Pulse **Home** (↑) o **End** (↓) hasta que se visualice el ajuste deseado y seguidamente pulse **New Block** (←).

Después de imprimir con la función **Cut** ajustada a 3 o 4, pulse **Feed** para que avance la cinta y seguidamente pulse el botón del cortador para cortarla.

Ajuste del contraste del visualizador

Puede aclarar u oscurecer el visualizador seleccionando un ajuste entre **-2** y **+2**. (El ajuste predeterminado es **0**.) Cuanto mayor sea el valor, mayor será el contraste (más oscuro estará el visualizador). Cuanto menor sea el valor, menor será el contraste (más claro estará el visualizador).

- 1 Pulse **Code** y luego **Setup** **Z**.
- 2 Pulse **←** o **→** hasta que se visualice **CONTRAST**.
- 3 Pulse **Home** **↑** o **End** **↓** hasta que se visualice el ajuste deseado y seguidamente pulse **New Block** **←**.

Ajuste de la función de reducción automática

Con la función de reducción automática, puede seleccionar si la anchura del texto (**TEXT WIDTH**) o el tamaño del texto (**TEXT SIZE**) se reducirán o no en el caso de que un texto con ajuste de tamaño **AUTO** sea demasiado grande para la longitud de etiqueta que se ha definido. (El ajuste predeterminado es **TEXT SIZE**.)

- 1 Pulse **Code** y luego **Setup** **Z**.
- 2 Pulse **←** o **→** hasta que se visualice **AUTO REDUCTION**.
- 3 Pulse **Home** **↑** o **End** **↓** hasta que se visualice el ajuste deseado y seguidamente pulse **New Block** **←**.

Si selecciona **TEXT SIZE** y añade más texto, se reduce el tamaño de los caracteres para que el texto quepa en la longitud de etiqueta definida.

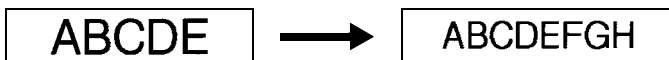

Si selecciona **TEXT WIDTH** y añade más texto, se reduce la anchura de los caracteres para que el texto quepa en la longitud de etiqueta definida. No obstante, una vez que la anchura de los caracteres se haya reducido a **MINIMUM**, se reducirá el tamaño de los mismos para que el texto quepa en la longitud de etiqueta definida.



Calibración de la longitud de la etiqueta

Si la longitud de la etiqueta impresa no se corresponde con la longitud especificada con la función de longitud, la longitud de la etiqueta impresa se puede recalibrar con la función de ajuste de longitud seleccionando un valor entre **-1** y **+3**. (El valor predeterminado es **0**.)

- 1 Pulse **Code** y luego **Setup** **Z**.
- 2 Pulse **←** o **→** hasta que se visualice **LENGTH ADJUST**.
- 3 Pulse **Home** **↑** o **End** **↓** hasta que se visualice el ajuste deseado y seguidamente pulse **New Block** **←**.

Definición de la actualización continua de la categoría de símbolos PERSONAL

Puede definir si, cuando se llene la categoría de símbolos **PERSONAL**, deben seguir añadiéndose símbolos **PERSONAL**, eliminando los más antiguos, (**ON**) o no (**OFF**). (El ajuste predeterminado es **ON**.)

- 1 Pulse **Code** y luego **Setup** **Z**.
- 2 Pulse **←** o **→** hasta que se visualice **SYMBOL SAVE**.
- 3 Pulse **Home** **↑** o **End** **↓** hasta que se visualice el ajuste deseado y seguidamente pulse **New Block** **←**.

Cambio de las unidades de medida

Las unidades usadas para indicar las medidas pueden ajustarse a milímetros (**mm**) o a pulgadas (**inch**). (El ajuste predeterminado es **inch**.)

- 1 Pulse **Code** y luego **Setup** **Z**.
- 2 Pulse **←** o **→** hasta que se visualice **UNITS**.
- 3 Pulse **Home** **↑** o **End** **↓** hasta que se visualice el ajuste deseado y seguidamente pulse **New Block** **←**.

Cambio del idioma

El idioma de los menús, ajustes y mensajes se puede cambiar seleccionando **ENGLISH** o **FRANÇAIS**. (El ajuste predeterminado es **ENGLISH**.)

- 1 Pulse **Code** y luego **Setup** **Z**.
- 2 Pulse **←** o **→** hasta que se visualice **LANGUAGE**.
- 3 Pulse **Home** **↑** o **End** **↓** hasta que se visualice el ajuste deseado y seguidamente pulse **New Block** **←**.

Visualización de información sobre la versión

Esta función puede usarse para ver información sobre la versión del software P-touch y del juego de símbolos incorporados.





- 1 Pulse **Code** y luego **Setup** **Z**.
- 2 Pulse **←** o **→** hasta que se visualice **VERSION INFO**.
- 3 Pulse **Home** **↑** o **End** **↓** hasta que se visualice la información de versión deseada.
- 4 Pulse **New Block** **←** para salir del modo de configuración.

5 Apéndice

Solución de problemas

Problema	Solución
1 El visualizador se queda en blanco después de haber conectado la máquina.	<ul style="list-style-type: none">• Compruebe que el adaptador de CA (modelo AD-60/AD-24) esté correctamente enchufado.• Si está empleando pilas, compruebe que estén correctamente insertadas.• Si las pilas están gastadas, cámbielas por otras nuevas.
2 La máquina no imprime o los caracteres impresos quedan borrosos.	<ul style="list-style-type: none">• Compruebe que la cubierta posterior esté bien colocada.• Si el casete de cinta está vacío, cámbielo por otro nuevo.
3 Los archivos de texto que había almacenado en la memoria ya no están.	<ul style="list-style-type: none">• Si las pilas están gastadas, cámbielas por otras nuevas.
4 Los caracteres impresos no se forman correctamente.	<ul style="list-style-type: none">• Si está empleando pilas, quizá estén gastadas. Pruebe a utilizar el adaptador de CA o cambie las pilas por otras nuevas.
5 Aparece una línea horizontal en blanco a lo largo de la etiqueta impresa.	<ul style="list-style-type: none">• Limpie el cabezal de impresión como se explica en <i>Limpieza del cabezal de impresión, rodillos y cortador de la cinta</i> en la página 7.
6 Aparecen franjas.	<ul style="list-style-type: none">• Se ha terminado la cinta. Cambie el casete de cinta por otro nuevo.
7 La P-touch se ha “bloqueado” (es decir, no responde cuando se presiona una tecla).	<ul style="list-style-type: none">• Apague la P-touch y, después, mientras mantiene presionadas (Code) y (R), vuelva a encenderla. La máquina se restaurará, pero el texto y los formatos que aparecen en el visualizador así como todos los archivos de texto almacenados en la memoria quedarán borrados.

Lista de mensajes de error

Mensaje de error	Causa	Solución
1 BLOCK LIMIT!	<ul style="list-style-type: none"> Aparecerá este mensaje si intenta usar la función de numeración cuando se hayan introducido múltiples bloques de texto con el modo de tipo de etiqueta PANEL seleccionado. 	<ul style="list-style-type: none"> Cancele la función de numeración. Límite a 1 el número de bloques de texto.
7 LINE LIMIT!	<ul style="list-style-type: none"> Este mensaje aparecerá si se han escrito 7 líneas en un bloque de texto al pulsar . 	<ul style="list-style-type: none"> Límite a 7 el número de líneas de un bloque de texto.
	<ul style="list-style-type: none"> Este mensaje aparece si borra , haciendo que el número de líneas de un bloque exceda el límite de 7. 	<ul style="list-style-type: none"> Ajuste el número de líneas de forma que el bloque no tenga más de 7.
50 LINE LIMIT REACHED!	<ul style="list-style-type: none"> Este mensaje aparecerá si se han escrito 50 bloques de texto al pulsar  y luego . 	<ul style="list-style-type: none"> Límite a 50 el número de bloques de texto.
BUFFER EMPTY!	<ul style="list-style-type: none"> Este mensaje aparecerá si no se ha escrito ningún texto al intentar imprimir o usar la función de vista preliminar. 	<ul style="list-style-type: none"> Escriba algún texto antes de intentar realizar cualquiera de estas operaciones.
BUFFER FULL!	<ul style="list-style-type: none"> Este mensaje aparecerá si intenta introducir un carácter, un espacio, una nueva línea, un nuevo bloque, un símbolo, un carácter acentuado o un código de barras cuando ya haya escrito el número máximo de caracteres. 	<ul style="list-style-type: none"> Borre parte del texto existente antes de intentar añadir más.
CASSETTE CHANGED!	<ul style="list-style-type: none"> Este mensaje aparecerá si se ha cambiado el casete de cinta durante la pausa de la P-touch para cortar la cinta. 	<ul style="list-style-type: none"> Vuelva a colocar el casete de cinta anterior.
CHECK BATTERIES!	<ul style="list-style-type: none"> Este mensaje aparecerá si se ha instalado una combinación de pilas nuevas y usadas, una combinación de pilas de diferentes tipos (alcalinas, Ni-Cd y Ni-MH), fabricantes o modelos, o una combinación de pilas recargadas y sin recargar. 	<ul style="list-style-type: none"> Cámbielas por seis pilas AA nuevas del mismo tipo. Si instala pilas recargables, recárguelas todas.

Mensaje de error	Causa	Solución
<p>CHECK SETTING IN LABEL TYPE MODE!</p>	<ul style="list-style-type: none"> Este mensaje aparecerá si intenta cambiar los ajustes de la función de longitud o de la función de marco cuando ya se ha seleccionado un modo de tipo de etiqueta con una longitud o marco predefinido. 	<ul style="list-style-type: none"> Seleccione otro modo de tipo de etiqueta.
<p>En cinta de 3/4" (18 mm): CHECK THE NUMBER OF LINES! 5 MAX</p> <p>En cinta de 1/2" (12 mm): CHECK THE NUMBER OF LINES! 3 MAX</p> <p>En cinta de 3/8" (9 mm) y de 1/4" (6 mm): CHECK THE NUMBER OF LINES! 2 MAX</p>	<ul style="list-style-type: none"> Este mensaje aparecerá si intenta imprimir o usar la función de vista preliminar cuando el número de líneas del texto es mayor que el máximo posible para la cinta instalada. 	<ul style="list-style-type: none"> Reduzca el número de líneas o instale una cinta más ancha.
<p>CHOOSE COPIES LESS THAN 1000!</p>	<ul style="list-style-type: none"> Este mensaje aparecerá si se han seleccionado más de 1000 copias con las funciones de opciones de impresión. Observe que el número de copias más el número de etiquetas secuenciales no puede pasar de 1000. 	<ul style="list-style-type: none"> Seleccione menos de 1000 copias.
<p>CUTTER ERROR!</p>	<ul style="list-style-type: none"> Este mensaje aparecerá si el botón del cortador de la cinta estaba presionado cuando se ha pulsado Print o la cinta estaba avanzando. 	<ul style="list-style-type: none"> Suelte el botón cortador de la cinta. Si ha pulsado Print, pulse Feed para hacer avanzar la cinta impresa. Si no logra corregir el problema, póngase en contacto con su representante de servicio.
<p>INPUT WHOLE CODE!</p>	<ul style="list-style-type: none"> Este mensaje aparecerá si no se introduce el número de dígitos requerido en los datos del código de barras. 	<ul style="list-style-type: none"> Introduzca el número correcto de dígitos o cambie el protocolo de código de barras.
<p>INPUT ABCD AT BEGIN & END!</p>	<ul style="list-style-type: none"> Este mensaje aparecerá si no se ha introducido una letra entre A y D al principio y al final de los datos del código de barras cuando se haya seleccionado el protocolo CODABAR. 	<ul style="list-style-type: none"> Introduzca una letra entre A y D al comienzo y al final de los datos del código de barras.

Mensaje de error	Causa	Solución
INSERT 1" TAPE	<ul style="list-style-type: none"> Este mensaje aparecerá si no hay un casete de cinta de 1" (24 mm) de anchura instalado al intentar imprimir una plantilla de formato automático creada para cinta de esta anchura. 	<ul style="list-style-type: none"> Instale un casete de cinta de 1" (24 mm) de anchura.
INSERT 24mm TAPE		
INSERT 3/4" TAPE	<ul style="list-style-type: none"> Este mensaje aparecerá si no hay un casete de cinta de 3/4" (18 mm) de anchura instalado al intentar imprimir una plantilla de formato automático creada para cinta de esta anchura. 	<ul style="list-style-type: none"> Instale un casete de cinta de 3/4" (18 mm) de anchura.
INSERT 18mm TAPE		
INSERT 1/2" TAPE	<ul style="list-style-type: none"> Este mensaje aparecerá si no hay un casete de cinta de 1/2" (12 mm) de anchura instalado al intentar imprimir una plantilla de formato automático creada para cinta de esta anchura. 	<ul style="list-style-type: none"> Instale un casete de cinta de 1/2" (12 mm) de anchura.
INSERT 12mm TAPE		
INSERT 3/8" TAPE	<ul style="list-style-type: none"> Este mensaje aparecerá si no hay un casete de cinta de 3/8" (9 mm) de anchura instalado al intentar imprimir una plantilla de formato automático creada para cinta de esta (9 mm) anchura. 	<ul style="list-style-type: none"> Instale un casete de cinta de 3/8" (9 mm) de anchura.
INSERT 9mm TAPE		
INSERT 1/4" TAPE	<ul style="list-style-type: none"> Este mensaje aparecerá si no hay un casete de cinta de 1/4" (6 mm) de anchura instalado al intentar imprimir una plantilla de formato automático creada para cinta de esta (6 mm) anchura. 	<ul style="list-style-type: none"> Instale un casete de cinta de 1/4" (6 mm) de anchura.
INSERT 6mm TAPE		
LENGTH LIMIT!	<ul style="list-style-type: none"> Este mensaje aparecerá si intenta imprimir o usar la función de vista preliminar cuando la longitud del texto es mayor que el límite de 3' 1/3" (1 m). 	<ul style="list-style-type: none"> Borre parte del texto.
MEMORY FULL!	<ul style="list-style-type: none"> Este mensaje aparecerá si intenta almacenar un archivo de texto después de haber almacenado ya unos 2000 caracteres en la memoria. 	<ul style="list-style-type: none"> Borre un archivo que no necesite a fin de dejar espacio para el nuevo.
MIN 4 DIGITS!	<ul style="list-style-type: none"> Este mensaje aparecerá cuando haya introducido menos del mínimo de cuatro dígitos como datos del código de barras. 	<ul style="list-style-type: none"> Introduzca un mínimo de cuatro dígitos antes de pulsar ."/>

Mensaje de error	Causa	Solución
NO FILES!	<ul style="list-style-type: none"> Este mensaje aparecerá si intenta invocar o borrar un archivo de texto de la memoria sin que haya ninguno almacenado. 	<ul style="list-style-type: none"> Antes de intentar invocar o borrar un archivo de texto, almacénelo.
NO TAPE!	<ul style="list-style-type: none"> Este mensaje aparecerá si no hay un casete de cinta instalado al intentar avanzar la cinta, imprimir o utilizar la función de vista preliminar. 	<ul style="list-style-type: none"> Instale un casete de cinta y pruebe de nuevo.
TEXT TOO HIGH! XX BLOCK	<ul style="list-style-type: none"> Este mensaje aparecerá si el tamaño del texto es más grande que el ancho de la cinta instalada. 	<ul style="list-style-type: none"> Reduzca el tamaño de los caracteres, instale una cinta más ancha o seleccione el ajuste de tamaño de texto AUTO.
TEXT TOO LONG!	<ul style="list-style-type: none"> Este mensaje aparecerá si la longitud del texto es mayor que la longitud que se ha ajustado para la etiqueta con la función de longitud. 	<ul style="list-style-type: none"> Pulse $\overset{\text{Length}}{\text{A}}$ y seguidamente seleccione una longitud de etiqueta mayor. Reduzca el tamaño o la anchura de los caracteres, o seleccione el ajuste de tamaño de texto AUTO.
TEXT TOO LONG! XX BLOCK	<ul style="list-style-type: none"> Este mensaje aparecerá si intenta imprimir una etiqueta más larga que la longitud de bloque definida. 	<ul style="list-style-type: none"> Seleccione una longitud de bloque más larga.
VALUE OUT OF RANGE!	<ul style="list-style-type: none"> Este mensaje aparecerá si el valor introducido al ajustar la función de márgenes, longitud o longitud de bloque no está dentro de los límites permitidos. Este mensaje aparecerá si los valores de los bloques a imprimir no están dentro de los límites permitidos. 	<ul style="list-style-type: none"> Escriba un valor que esté dentro de los límites permitidos.

Características técnicas de la máquina

Hardware

Alimentación:	Seis pilas AA alcalinas o bien Seis pilas AA recargables o bien Adaptador de CA (modelo AD-60/AD-24)
Dispositivo de entrada:	Teclado (56 teclas)
LCD:	48 × 132 puntos + Caps y otros indicadores
Cinta de impresión:	La cinta TZ está disponible en estas 5 anchuras: 1/4" (6 mm) 3/8" (9 mm) 1/2" (12 mm) 3/4" (18 mm) 1" (24 mm)
Cabezal de impresión:	18,1 mm (altura)/180 ppp (resolución)
Cortador de la cinta:	Manual
Dimensiones:	Con el botón del cortador de la cinta: 5 1/4" (An) × 9 1/4" (Prf) × 3 3/8" (Al) (131 mm (An) × 235 mm (Prf) × 86 mm (Al)) Sin el botón del cortador de la cinta: 4 1/2" (An) × 9 1/4" (Prf) × 3 3/8" (Al) (114 mm (An) × 235 mm (Prf) × 86 mm (Al))
Peso:	1,23 lb. (560 g)

Software

Tipos de caracteres:	1 tipo de caracteres integrado (Helsinki)
Tamaños de caracteres:	AUTO más 7 tamaños en puntos (1, 2, 3, 4, 6, 9 y 12 mm (6, 9, 12, 18, 24, 36 y 48 puntos))
Estilos de caracteres:	Normal, Negrilla, Perfilada, Cursiva, Cursiva + Negrilla y Cursiva + Perfilada
Tamaño de la memoria intermedia:	Máximo de 512 caracteres Máximo de 7 líneas Máximo de 50 bloques
Tamaño de la memoria:	Unos 2000 caracteres

Índice alfabético

A

Adaptador de CA	8
ajuste de longitud	38
ajuste predeterminado.....	14
alineación	28
alineación del texto a la derecha	28
indicador.....	2
alineación del texto a la izquierda ...	28
indicador.....	2
alineación del texto centrada.....	28
indicador.....	2
alineación del texto justificada	28
indicador.....	2
almacenar	35
anchura	26
indicador.....	2

B

bloqueo	40
borrado	
archivos en memoria.....	36
texto	17

C

cabezal de impresión.....	7
cancelación.....	14
carácter	
anchura.....	26
estilo.....	27
tamaño.....	25
categoría de símbolos PERSONAL....	22
configuración	39
cinta	
casetes	4
cortador	7
Cinta con fuerza adhesiva extra	6
Cinta de identificación flexible	6

código de barras	
caracteres especiales.....	19
confirmación.....	14
copias	31
cursor	15

E

elección.....	14
ajuste predeterminado.....	14
estilo.....	27
estilo de texto cursiva	27
indicador.....	2
estilo de texto negrilla	27
indicador.....	2
estilo de texto perfilado.....	27
indicador.....	2

F

formato	25, 26, 27
formato global	
anchura de los caracteres	26
estilo de los caracteres	27
tamaño de caracteres	25
formato local	
anchura de los caracteres	26
estilo de los caracteres	27
tamaño de caracteres	25
función de acentos	17
función de borrado	17
función de código de barras	18
función de contraste	37
función de copias múltiples.....	31
función de corte	37
función de formato automático.....	29
función de longitud.....	23
función de marcos	24
función de márgenes.....	23
función de nuevo bloque	16

función de numeración	31
función de reducción automática.....	38

I	
idioma	39
impresión en cadena.....	37
impresión especular	33
imprimir	
serie de bloques de texto	33
indicador de ajuste de tipo de etiqueta..	2
indicador de código.....	2
indicador de inserción	2
indicador de longitud.....	2
indicador de marco.....	2
indicador de mayúscula individual	2
indicador de mayúsculas continuas....	2
indicador de pilas gastadas.....	2
indicadores	2
ajuste de tipo de etiqueta.....	2
alineación del texto a la derecha....	2
alineación del texto a la izquierda..	2
alineación del texto centrada	2
alineación del texto justificada.....	2
anchura.....	2
código.....	2
estilo de texto cursiva.....	2
estilo de texto negrilla	2
estilo de texto perfilado	2
inserción	2
longitud	2
marco	2
mayúscula individual	2
mayúsculas continuas	2
número de bloque	2
pilas gastadas.....	2
tamaño.....	2
invocación	36

L	
letras mayúsculas.....	15
letras minúsculas	15

limpieza	
cabezal de impresión	7
cortador de la cinta	7
rodillos.....	7

M	
márgenes de la etiqueta	23
medidas	39
mensajes de error	41
modo Bandera.....	11
modo Bloque de puertos	12
modo de mayúscula individual.....	15
modo de mayúsculas continuas	15
modo de tipo de etiqueta	9
modo Girar	10
modo Girar y repetir	10
modo Normal.....	9
modo Panel.....	12
modo Puerto	12
modo Vertical	9

N	
número de bloque	2
números.....	15

P	
pausa para corte	37
pilas.....	4
plantillas	
formato automático.....	29
problemas	40

R	
rodillos	7

S	
selección.....	14, 15
ajuste predeterminado.....	14
serie de bloques	33
solución de problemas.....	40

T

tamaño	25
indicador.....	2
tecla de alimentación.....	2, 8
tecla de avance	2, 30
tecla de configuración.....	37
tecla de espaciado	14, 15
tecla de formato.....	25, 26, 27
tecla de formato global	2
tecla de impresión	2, 30
tecla de inserción	16
tecla de memoria	35
tecla de retorno	2, 14, 16
tecla de retroceso	2, 14, 17
tecla de símbolo	20
tecla de tipo de etiqueta	2
teclado.....	2
teclas de flechas	2, 14, 15
Teclas numéricas	2
texto	
ajuste de anchura.....	38
ajuste de tamaño.....	38
alineación	28
anchura.....	26
estilo.....	27
tamaño.....	25

U

unidades	39
----------------	----

V

versión	39
vista preliminar.....	30
visualizador.....	2
contraste	37
visualizador de LCD	2

Información de contacto (sólo para EE.UU.)

Centros de servicio

Si necesita un centro de servicio local, llame al teléfono 1-800-284-HELP (4357) para averiguar cuál es el centro de servicio autorizado que le queda más cerca.

Nota: Llame al centro de servicio antes de desplazarse.

Los centros de servicio no prestan asistencia operativa. Consulte "Asistencia operativa".

Asistencia operativa

Si necesita asistencia técnica y operativa, puede llamar al Servicio de atención al cliente de Brother en: Voz 1-877-4-PTouch, o Fax 1-901-379-1210

Asistencia por Internet

Para obtener información sobre productos y descargar los controladores más recientes: <http://www.brother.com>

Para adquirir accesorios y determinados productos Brother: <http://www.brothermall.com>

Accesorios y suministros

Para pedir accesorios y suministros Brother pagando con Visa, MasterCard, Discover o American Express, puede llamar al número gratuito 1-888-879-3232 o rellenar el formulario de pedido que encontrará en la Guía del usuario y enviar ambas caras del formulario por fax al número 1-800-947-1445.

Para adquirir accesorios en Internet: <http://www.brothermall.com>

Para hacer su pedido por correo o pagar con talón, rellene el formulario de pedido de accesorios y envíelo con el abono a nombre de:

Brother International Corporation
Attn: Consumer Accessory Division
P.O. Box 341332
Bartlett, TN 38133-1332

Sistema de respuesta por fax

El Servicio de atención al cliente de Brother ha instalado un sencillo sistema de respuesta por fax que le permitirá obtener respuesta instantánea a preguntas técnicas frecuentes, así como información sobre todos los productos de Brother. Este sistema está disponible 24 horas al día, 7 días a la semana. Puede usar el sistema para enviar la información a cualquier número de fax, no sólo al número desde el que llama.

Llame al 1-800-521-2846 y siga las indicaciones de voz para recibir por fax instrucciones sobre cómo usar el sistema, así como un índice de los temas de respuesta por fax.

Ahorre tiempo - Regístrese en Línea!

No pierda tiempo al teléfono. Despreocúpese por el correo. Visítenos en

www.registermybrother.com

Regístre su producto inmediatamente en nuestra base y listo.

También en su visita, encuentre información útil y participe en sorteos!

☞ Toda la información es solamente para clientes en EE.UU.

brother®